

Test for GreenYellow Color

Example 1: Steel

Test for IndianRed Color

This example will explain step by step the creation of a basic 3D steel structure. This example will be most effective if the user practice the illustrated skills as they are presented.

The structure to be entered in this example is shown below:

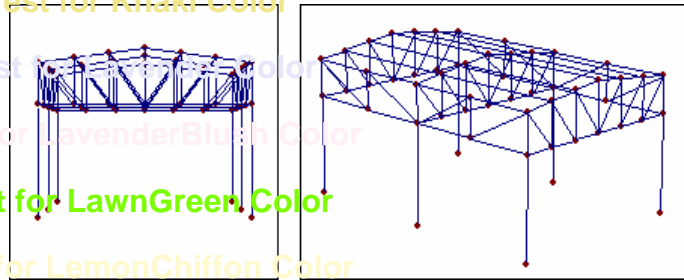

Text on each page

In order to simplify data entry, frame members are grouped as follows:

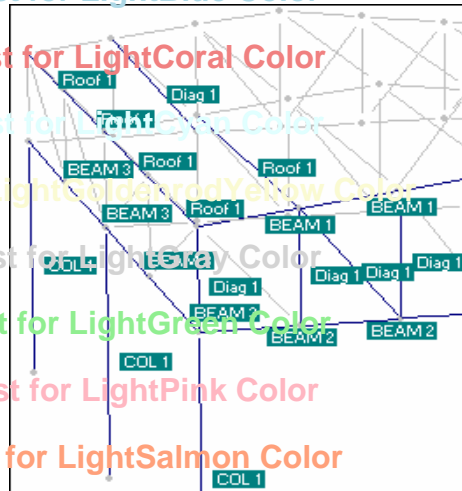

The assignment of the member descriptions shown here will be illustrated in this example.

1) Starting a new structure

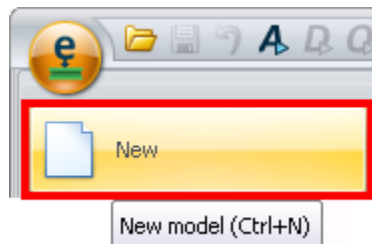

Select **New** from the RAM Elements button menu.

In the event that there is an existing model open, RAM Elements will ask to save it.

Test for LightSkyBlue Color

Example 1: Steel

Test for LightSlateGray Color

Test for LightSteelBlue Color

Test for LightYellow Color

Test for Lime Color

Test for LimeGreen Color

Press the button on the status bar, a menu will be displayed. Then, select the option Units configuration.

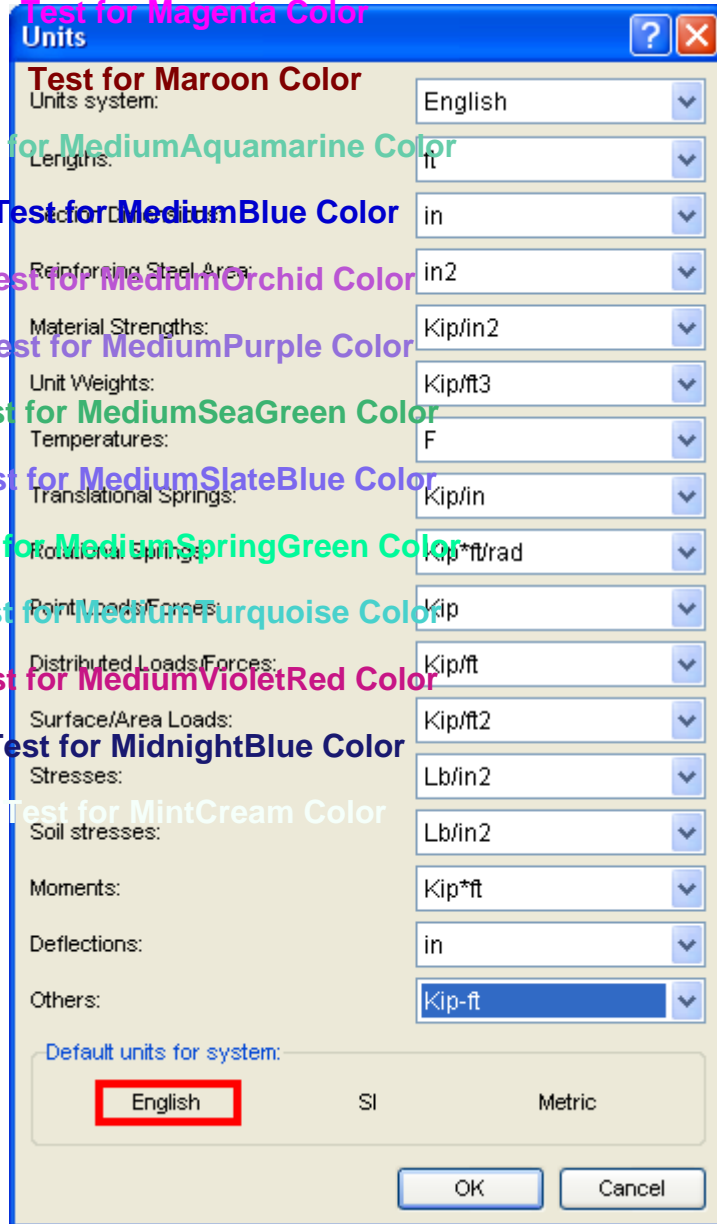

Text on each page

Select the English default unit system in the window displayed.

Test for MistyRose Color

Test for Moccasin Color

2) Entering node coordinates

In the coordinates spreadsheet enter the coordinates shown below:

Test for OldLace Color

Test for Olive Color

Test for OliveDrab Color

Test for Orange Color

Test for OrangeRed Color

Test for Orchid Color

Test for PaleGoldenRod Color

Test for PaleGreen Color

Node	X	Y	Z
0	0	0	36
20	0	12	36
22	0	16.5	36
27	12	18	36
31	24	12	36
32	24	0	36

Text on each page

Go to the Spreadsheet Nodes/Coordinates and enter the coordinates shown above.

Test for PaleTurquoise Color

Test for PaleVioletRed Color

Test for PapayaWhip Color

Test for PeachPuff Color

Test for Peru Color

The entered nodes are shown on the screen.

Test for PowderBlue Color

3) Generation of frame members

Test for RoyalBlue Color

Select the path of the frame members. Select the nodes in the sequence shown below, and then

Test for RosyBrown Color

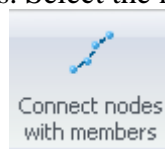

connect the selected nodes by pressing

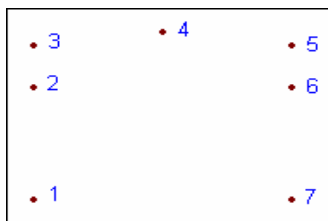

Select the nodes in the order shown. To select several nodes remember to press the SHIFT key while clicking with the mouse.

Test for SaddleBrown Color

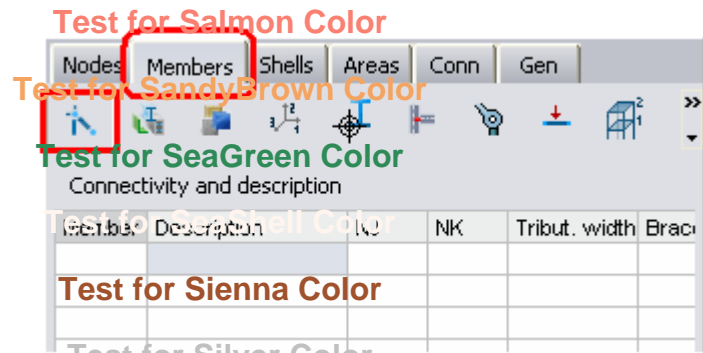

Go to the Spreadsheet **Members/Nodes and Description**

Test for SkyBlue Color

Test for SlateBlue Color

Text on each page

Test for SlateGray Color to generate the frame members.

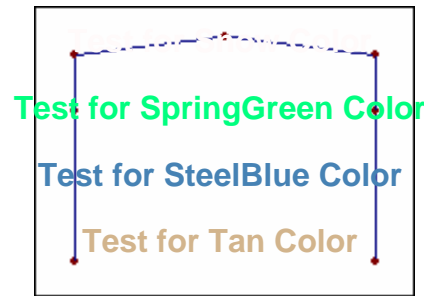

As can be seen the frame members were generate.

Test for Teal Color

NOTE. - Remember that it is possible to undo the last operation by pressing 

Test for Thistle Color

4) Assigning a description

It is necessary to group frame members in order to simplify later operations such as selection of elements, optimization, and others. To assign the same description to every member of a group proceed as follows:

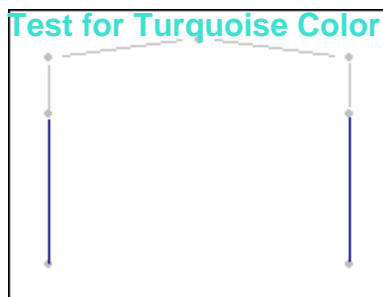

Select columns

Test for Violet Color

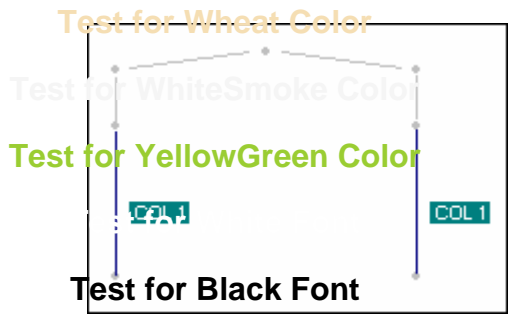

Test for Brown Font



Test for Navy Font

Test for Blue Color

Text on each page

Test for Pink Color



Test for Purple Color



Test for Yellow Color



Test for Red Color



Then assign the description to the selected members selecting the Column (additive) option.

Note. – To view the member descriptions graphically (on the screen) go to *View tab, Model group*, press the  button and select the option *Description by element* from the menu displayed.

Repeat the steps explained previously to assign a Description to the other members:

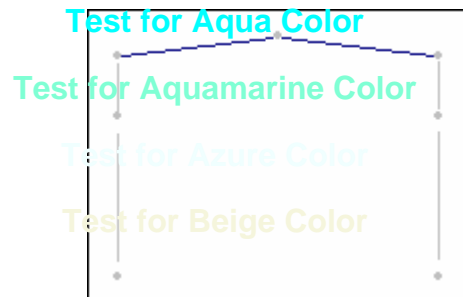

Select members

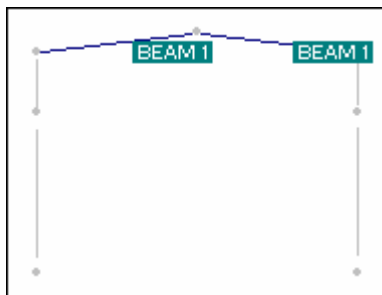

Assign the description to the selected members selecting the Beam (additive) option.

Generate the beam as shown in the figure below. Assign BEAM2 description to this newly created member:

Example 1: Steel

Test for BlanchedAlmond Color



Test for Chocolate Color

Test for Coral Color

To create the horizontal beam, select the nodes shown in this figure and press

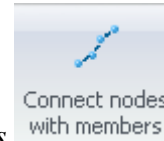

Text on each page

Test for Cornflower Blue Color

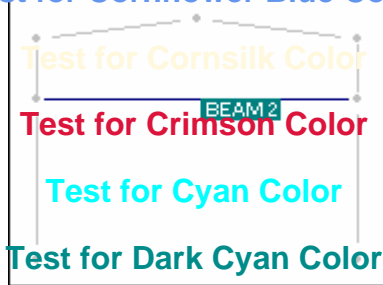

Assign the description to the selected members selecting the Beam (additive) option.

5) Segmenting Members

To segment frame members, follow these steps:

Test for DarkGreen Color

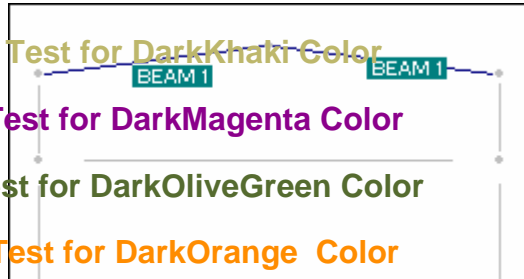

Test for DarkMagenta Color

Test for DarkOliveGreen Color

Test for DarkOrange Color

Select members to be segmented.

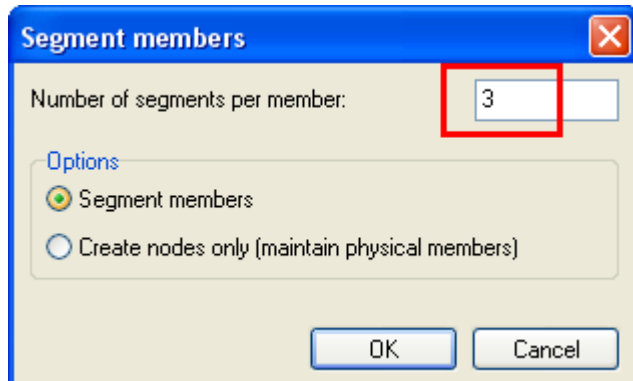

Test for DarkOrchid Color

Test for DarkRed Color

Test for DarkSalmon Color

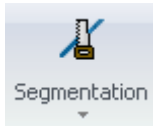

Press from the menu displayed after pressing the button located in the ribbon (visible when the Members tab is the current page in the spreadsheet and connectivity button is pressed) and enter the desired number of segments (3 segments in this case). Then press OK. Notice that in this case 3 physical elements will be created.



Text on each page

Next, segment the horizontal member BEAM2. To do this:



Select BEAM2 member

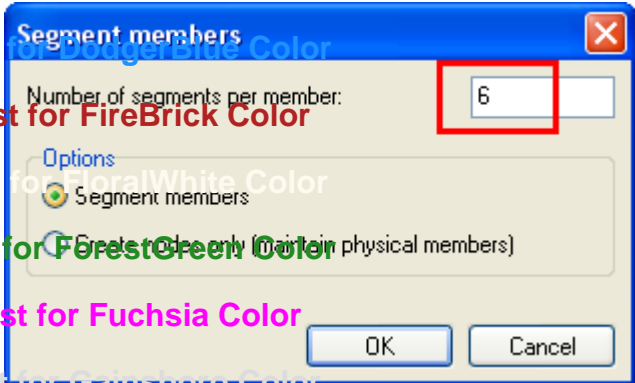

Press and enter the desired number of segments. In this case, enter six segments. Then press OK or the ENTER key.

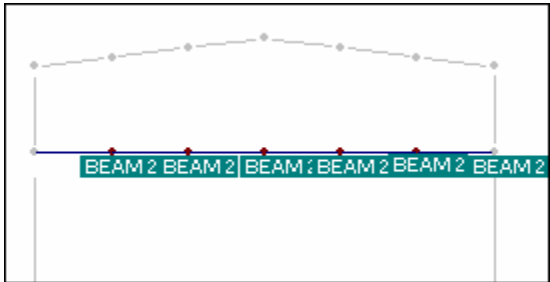

NOTE. - Remember that it is possible to undo the last operation by pressing .

Notice that the segmented members have the same description as the original member and that each member is treated as one physical member.

6) Generation of vertical members

To enter the vertical truss elements, follow these steps:

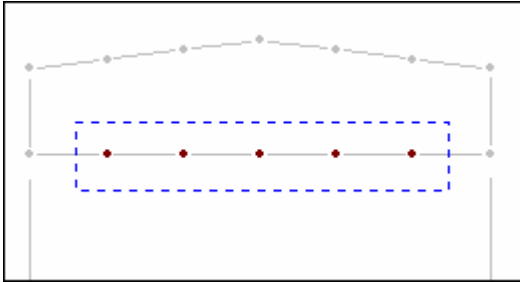

Text on each page

Select the nodes shown in this figure. Notice that it is not necessary to select the exterior nodes.

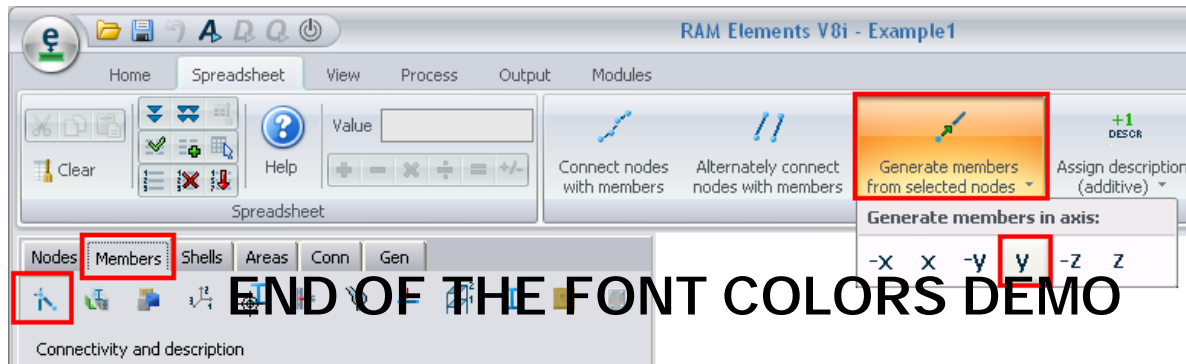
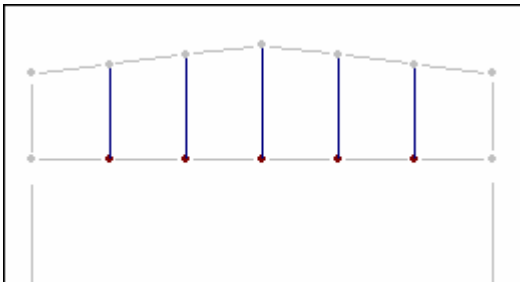

Press button  to generate vertical members (plus y generates members in the vertical up direction).

7) Generation of diagonal members

At first, generate the diagonal truss web members of the left side of the structure, and then the right side.

Diagonal members on the left side:

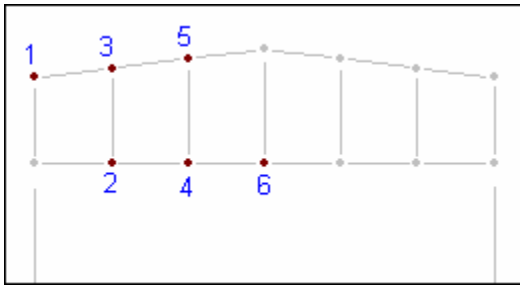

Select the nodes in the order shown in this figure.

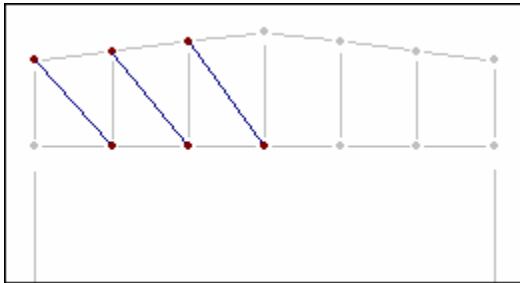

Text on each page

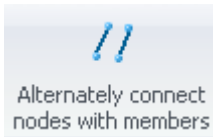

Press **Alternately connect nodes with members** from the ribbon (the button is visible when the Members tab is the current page in the spreadsheet and connectivity button is pressed).

To enter diagonals on the right side proceed in the same way.

NOTE. - Remember that it is possible to undo the last operation by pressing .

The differences between the two buttons are as follows:



This button connects the selected nodes in a continuous line.



This button connects alternate pairs of nodes with a fragmented line. That is, the first member is generated between the first pair of selected nodes, the second member between the second pair of selected nodes, etc.

8) Assigning a Description to members

Follow these steps to assign a Description to the internal web members:

a) Select diagonal and vertical (internal) elements using the button  (Home tab, Selection group)

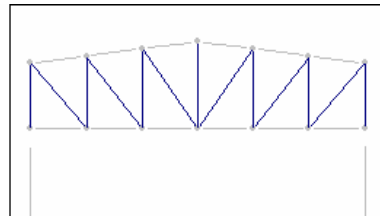
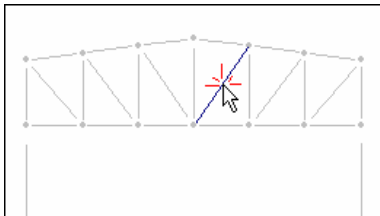

Example 1: Steel

To select the elements select one member of each group and then press . Remember that this button selects elements with a common description. In this case all internal elements belong to the group that does not have a description yet. That is to say they all have the same empty description.

b) Internal elements will be assigned a DIAG1 description. Since there is no button available to assign this description (as opposed to COL1 and BEAM1 buttons), it is necessary to enter it manually:

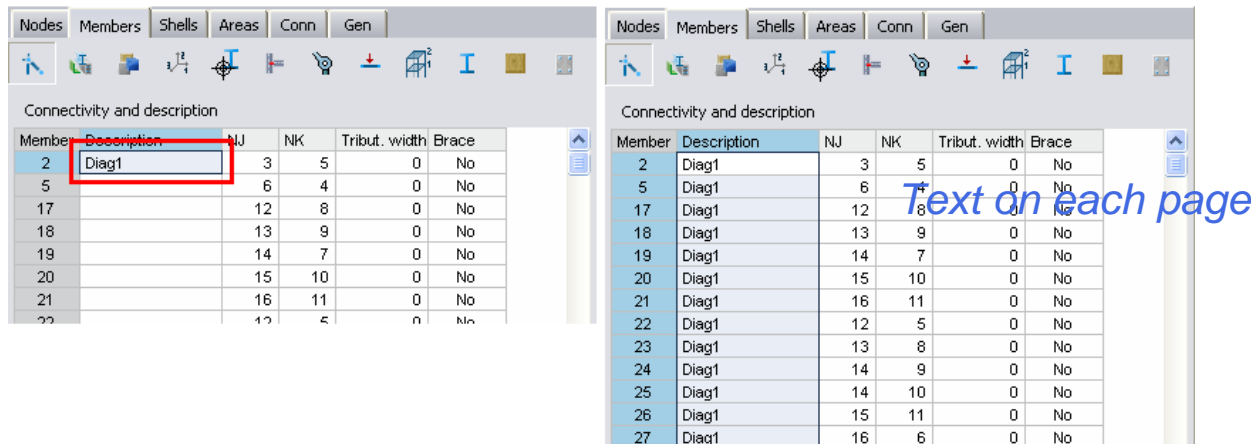

Enter DIAG1 description and then press  located at Spreadsheet tab, Spreadsheet group, to fill the column with the value. Another way to do this would be the access to command from the popup menu displayed after right click on the spreadsheet area, having selected the desired rows to fill previously.

Important - Descriptions are very important to select groups of frame members. It is also important to have entered the descriptions correctly. If this has not been done correctly the user may experience some difficulty following the next steps in this example.

9) Copying the structure

It is advisable to enter all the descriptions of a structure before copying it, because when a structure is copied the Descriptions are also copied.

To copy a structure, follow these steps:

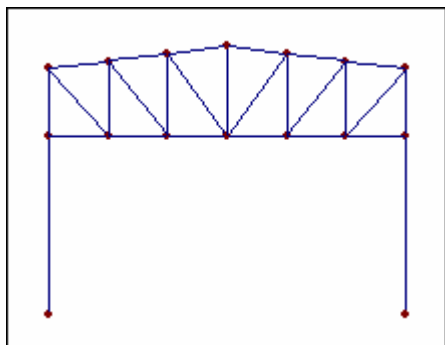

Select all the elements that should be copied. In this case, press  (Home tab, Data tab) to select the entire structure.

Execute the **Copy** command (Home tab, Modeling group).

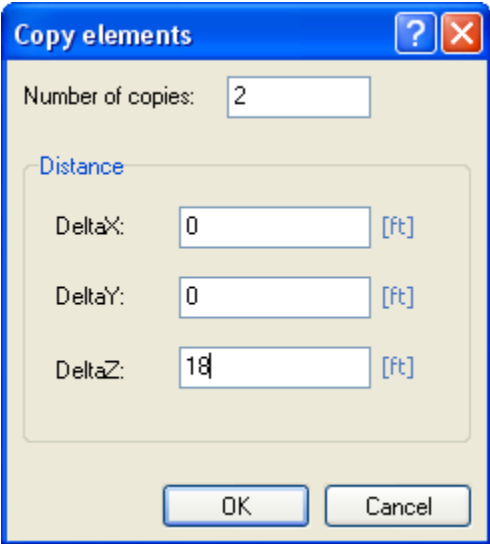
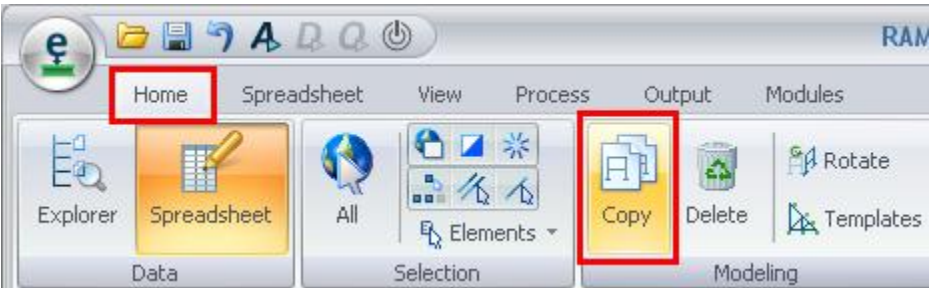

Text on each page

Enter the number of copies and the distances in X, Y, and Z between each copy. In this case, enter the values shown in this figure. Then press OK.

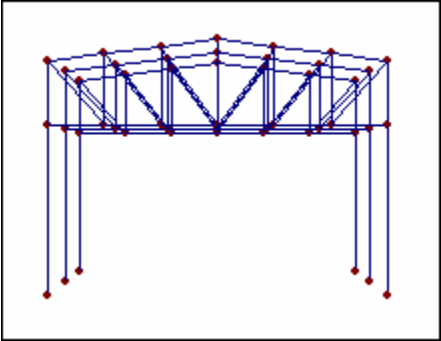

10) Generation of the roof beams (purlins)

To generate the roof beams, follow these steps:

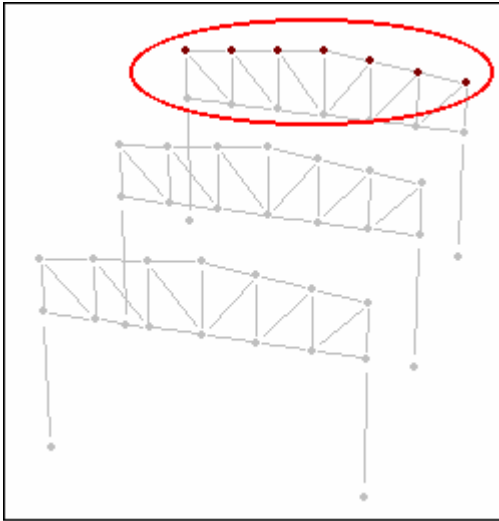

Text on each page

Select the initial nodes or end nodes of the roof beams.

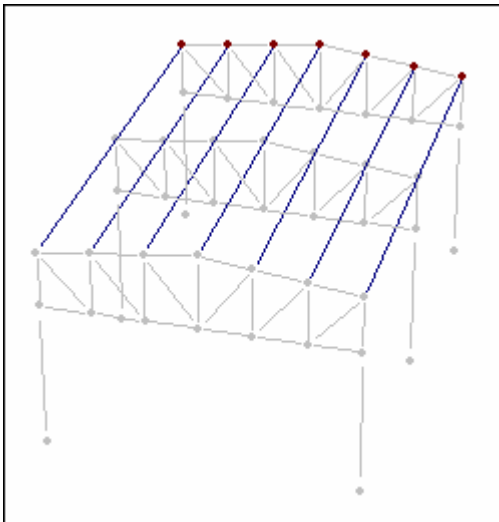

Then press **Z** (Press button **-Z** if nothing occurs). Note that the +/- refers to the direction that the members are projected.

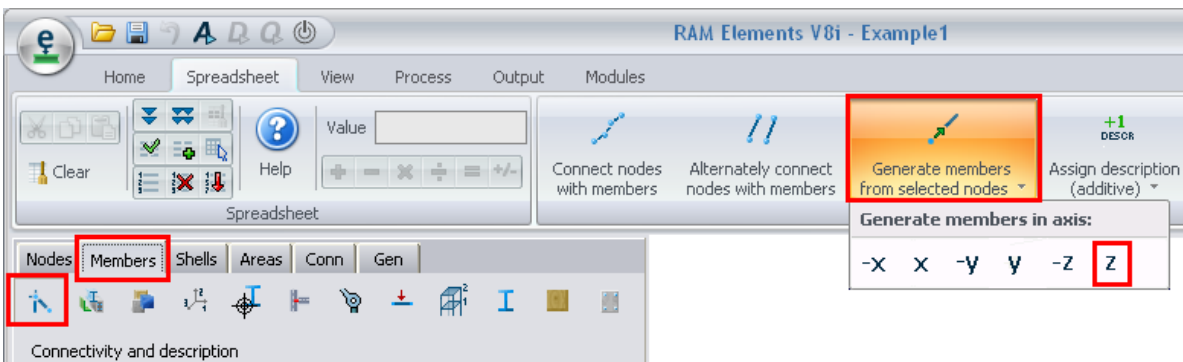

Note. - Notice that the middle portal is not connected to the roof beams. The model can be left without making any changes and the program will interpret the roof beams as continuous physical members. However, if the roof beams are going to be modeled as simply supported beams (as they normally are), it is necessary to segment the beams and connect one end to the middle portal. The

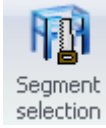

command Segment Selection may be applied in this case.

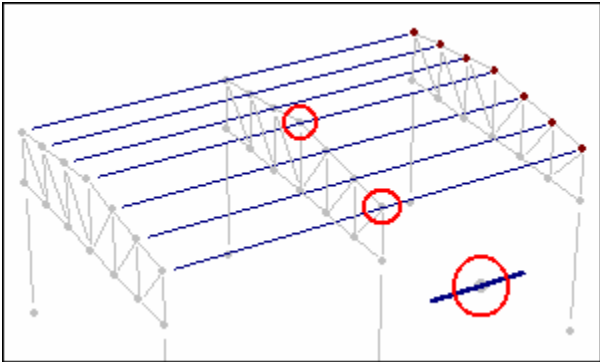

Text on each page

Notice that roof beams do not connect with the middle frame

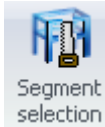
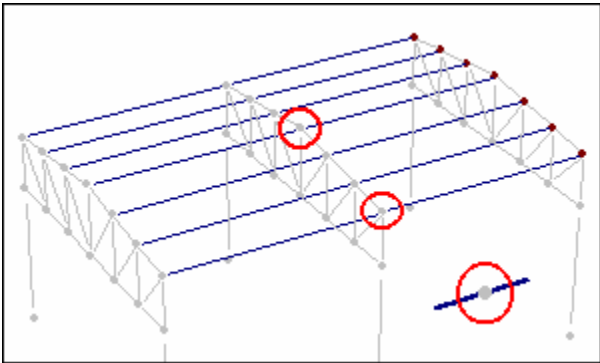

With the roof beams selected, press Segment selection to split roof beams and connect them with the middle portal. It is necessary to select the member and the node of the middle portal that will become the point of break.

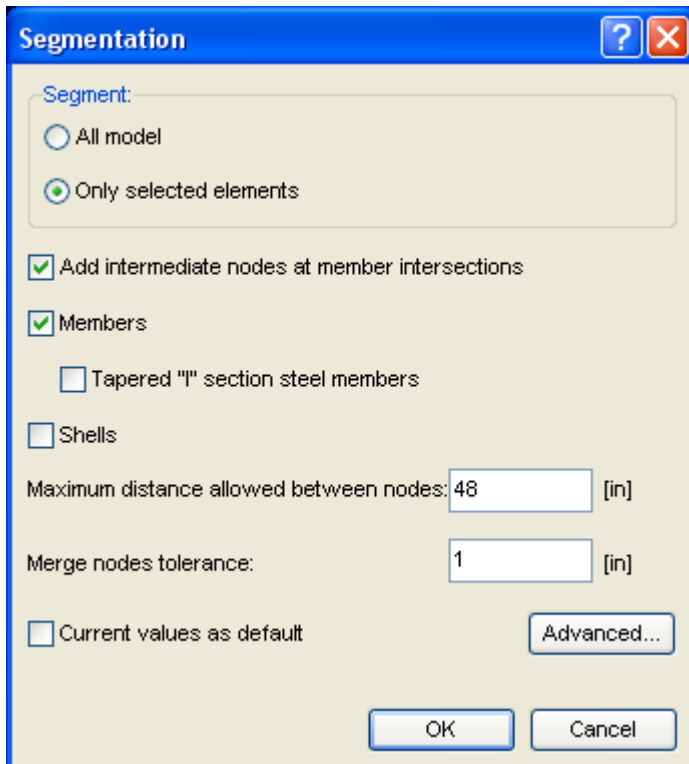

Text on each page

Choose the options shown in the figure. The members will be divided into two physical members.

11) Assigning a Description to roof beams

To assign a Description to roof beams, proceed as follows:

a) Select roof beams by description.

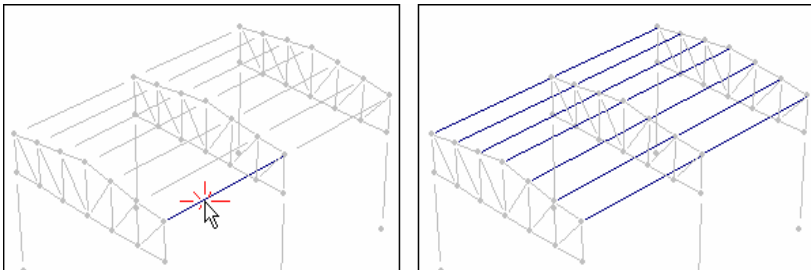

Select a member of the group and then press . Since the selected element does not have a description, all members with empty description will be selected.

b) ROOF1 description will be assigned to roof beams. There is no button available to automatically assign the description (as opposed to COL1 and BEAM1 descriptions). Therefore, the Description has to be entered manually:

Member	Description	NJ	NK	Tribut. width	Brace
82	Roof1	5	54	0	No
83		8	23	0	No
84		7	25	0	No
86		6	52	0	No
87		9	35	0	No
88		11	37	0	No
91		21	56	0	No
92		23	24	0	No
93		25	27	0	No
94		10	26	0	No
95		29	50	0	No

Member	Description	NJ	NK	Tribut. width	Brace
82	Roof1	5	54	0	No
83	Roof1	8	23	0	No
84	Roof1	7	25	0	No
86	Roof1	6	52	0	No
87	Roof1	9	35	0	No
88	Roof1	11	37	0	No
91	Roof1	21	56	0	No
92	Roof1	23	24	0	No
93	Roof1	25	27	0	No
94	Roof1	10	26	0	No
95	Roof1	29	50	0	No
96	Roof1	35	36	0	No
97	Roof1	37	38	0	No
101	Roof1	30	31	0	No
106	Roof1	52	29	0	No
111	Roof1	54	21	0	No
116	Roof1	56	22	0	No
120	Roof1	26	28	0	No

Text on each page

Enter ROOF 1 under description and then press  to fill the column with the entered value.

Generating DIAG2 and BEAM3 members

Now proceed to enter the DIAG2 and BEAM3 members that are shown in the figure below. Generate these elements as explained before.

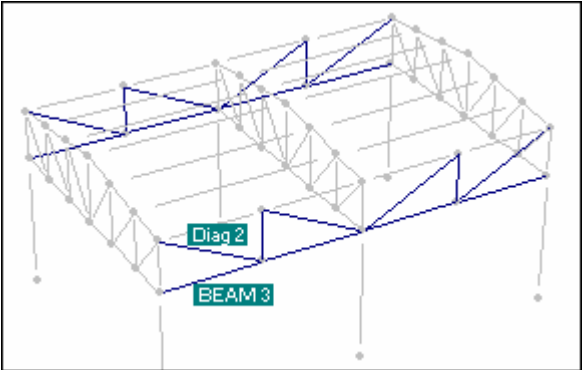

12) Supports

To enter supports proceed as follows:

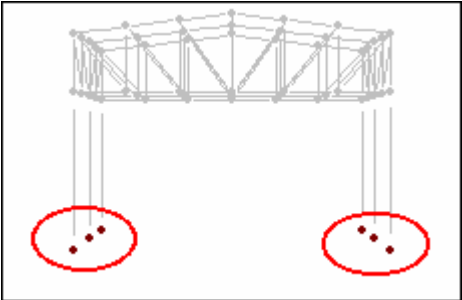

Select support nodes

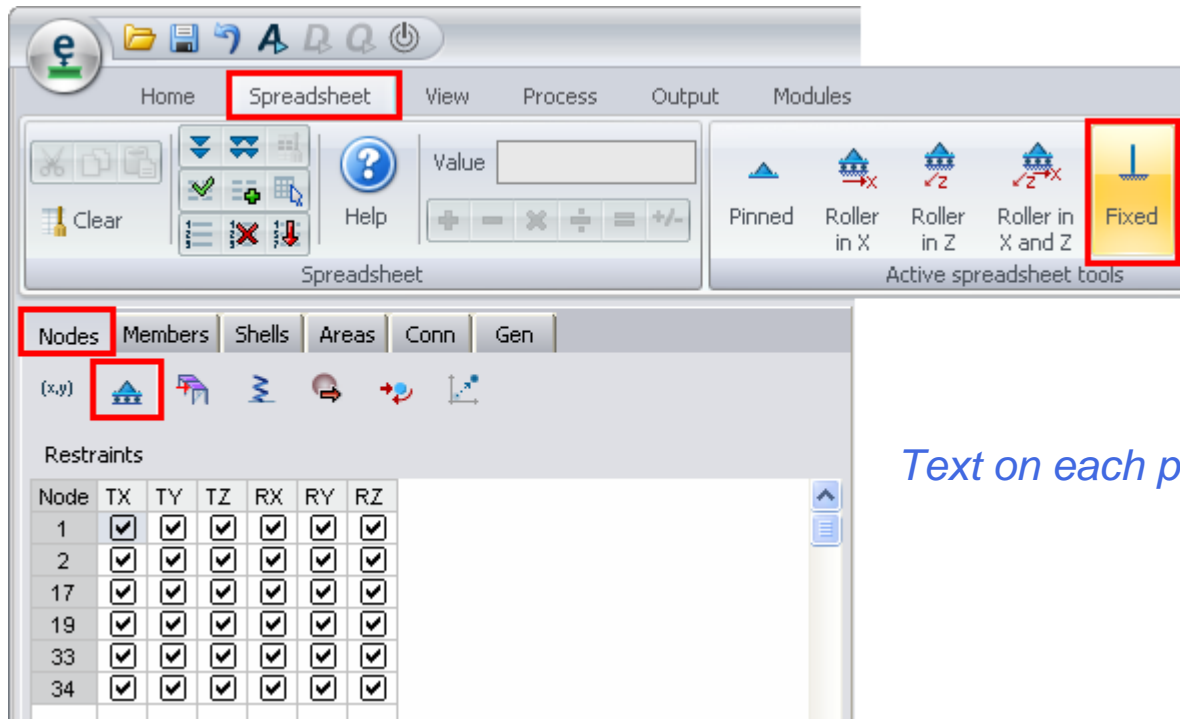

Text on each page

Go to the Spreadsheet **Nodes/Restraints** and click on the corresponding support. In this case click on



the **Fixed** button.

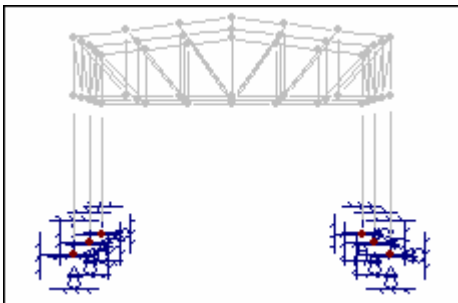



The Supports have been entered

13) Assigning sections to frame members.

To assign a section to some member, and this section is available in the section database, proceed as follows:

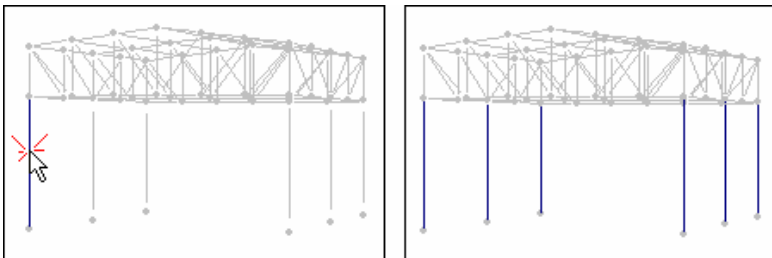
Select the members to which a section will be assigned. In this case, select all the columns.



To do this, first select one column and press .

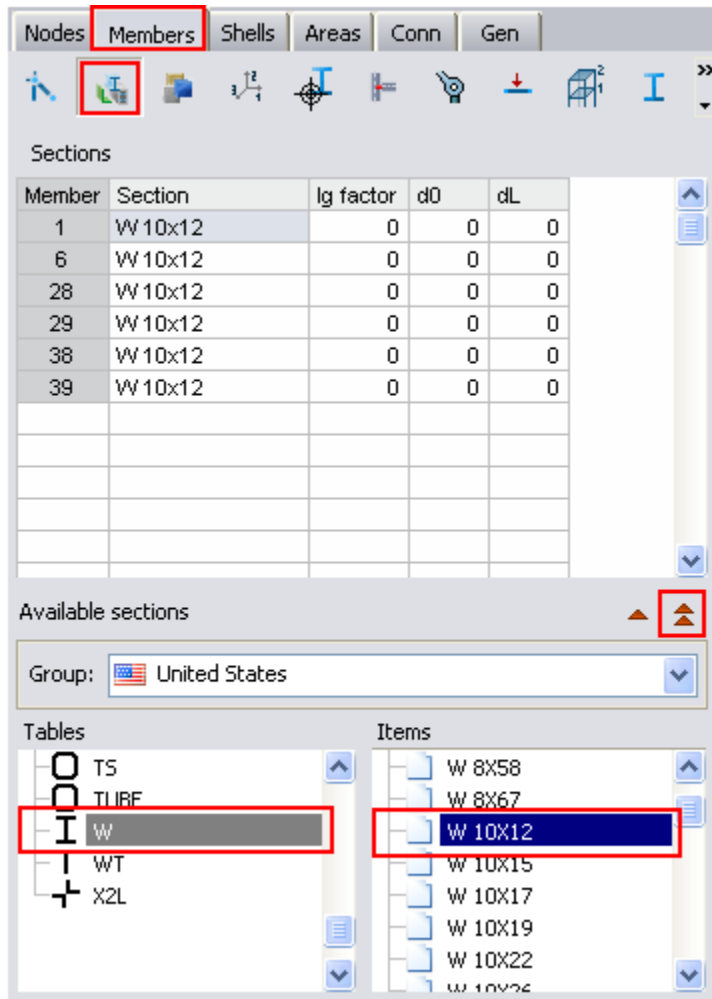

Text on each page

Then go to the Spreadsheet **Members/Sections**. Select W10x12 profile and press  (double click on the profile will assign the selected item).

Assign sections to all members of the structure in a similar manner.

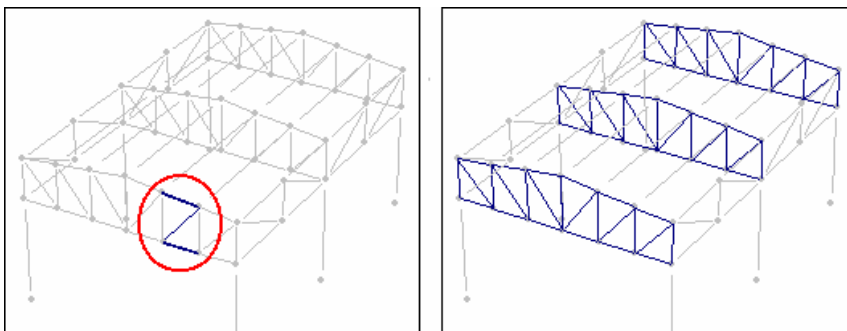

To select all the elements of the truss, select one element of each group and press .

Example 1: Steel

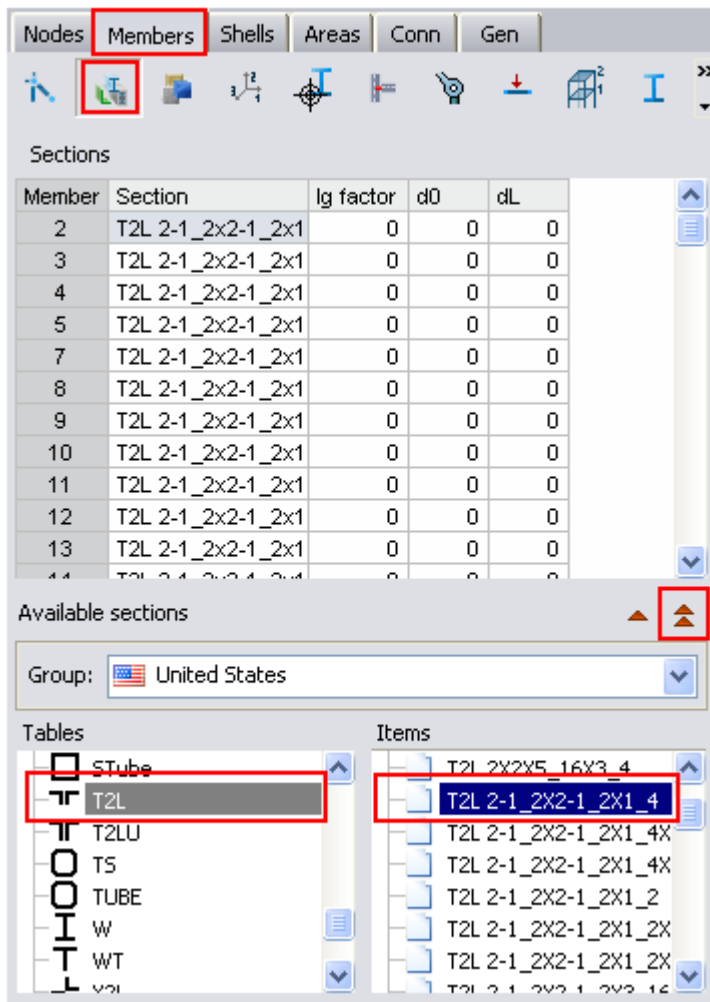

Text on each page

Assign section T2L 2-1_2x2-1_2x1_4 to the truss elements.

Now assign sections to the DIAG2 and BEAM3 elements

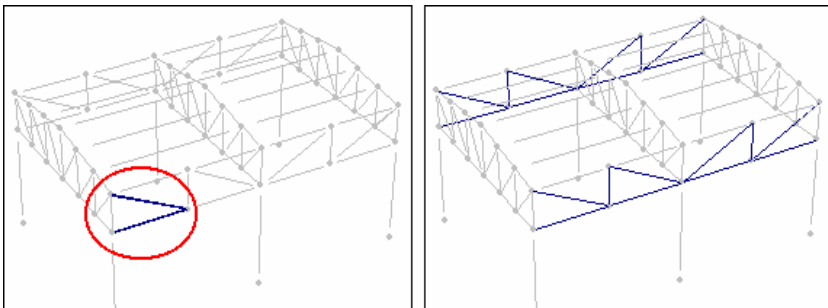

Select the elements DIAG2 and BEAM3

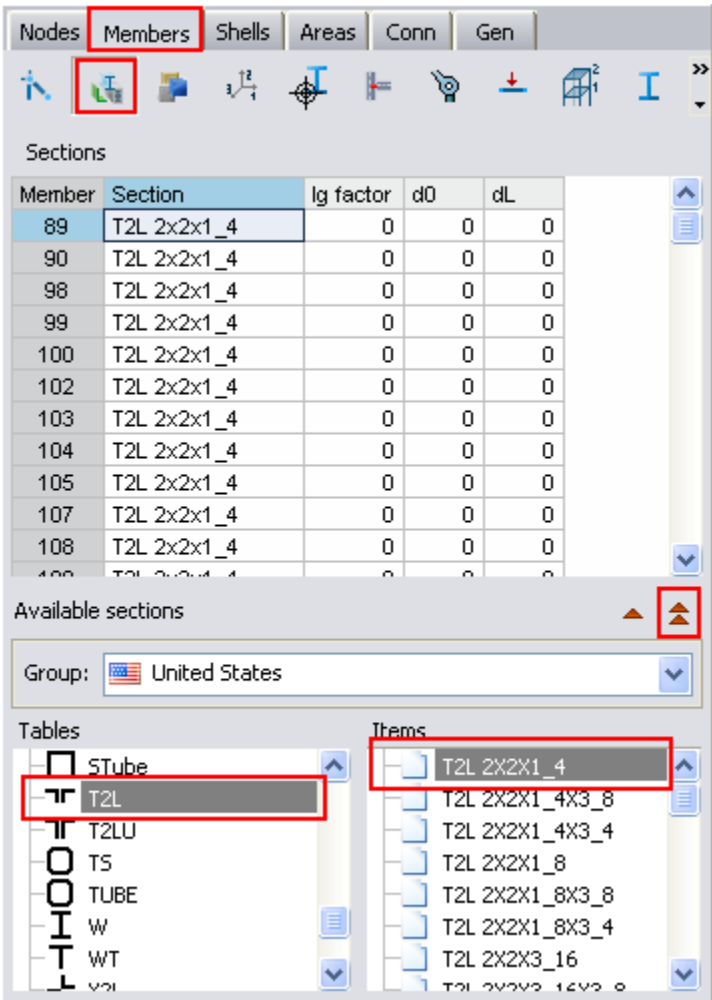

Text on each page

Assign section T2L 2x2x1_4

14) Adding sections to the database.

In this example, a cold-formed C-section will be assigned to the Roof beams. This cold-formed C (with lips) profile is not available in the section database. Therefore, a new section should be added. Proceed as follows:

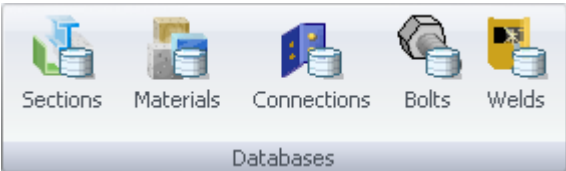

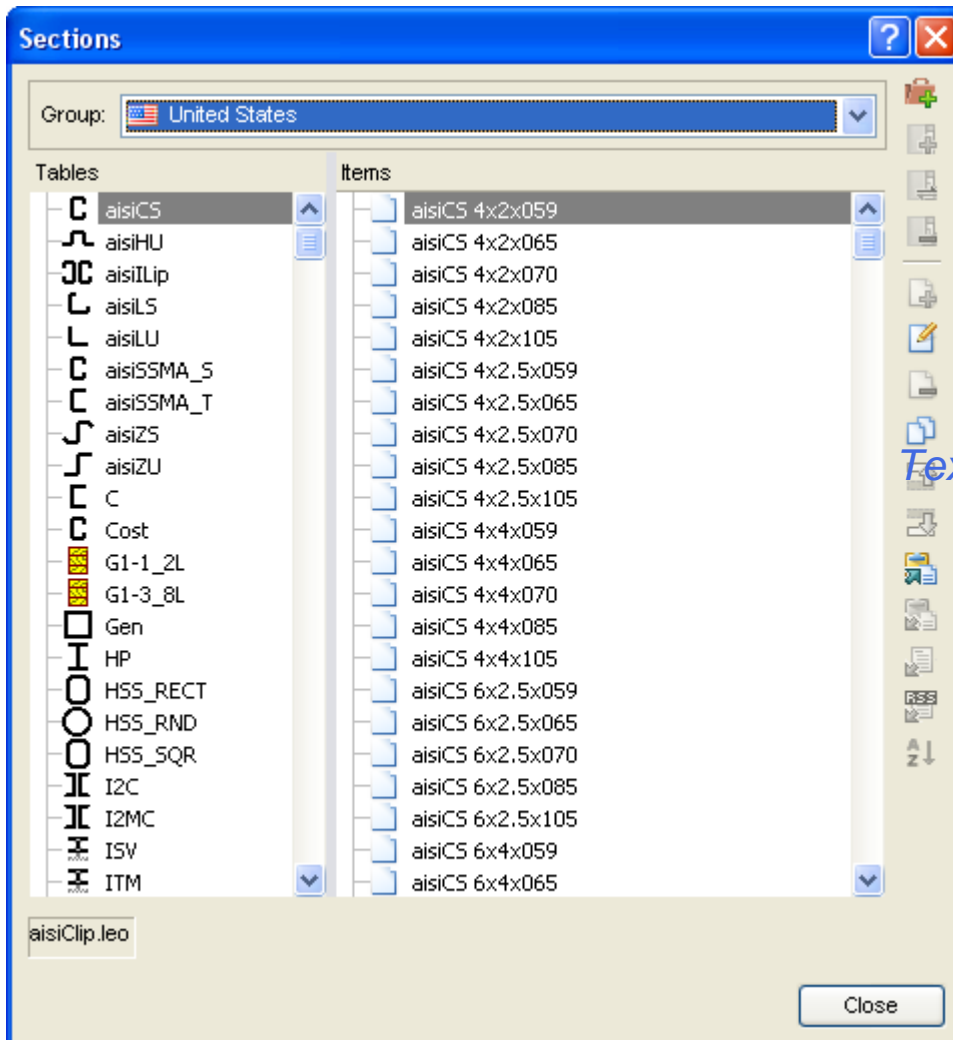

Go to the Home tab, Databases group and execute the Sections button

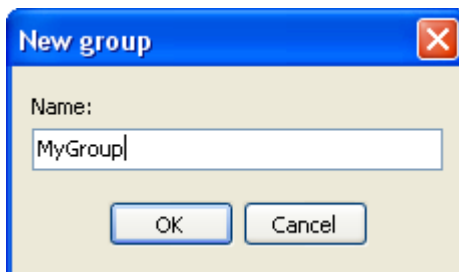

Press the  button to add a New group to the database. After that, a name for the new group is required in the displayed window:



Then, add a new Table by pressing the  button. A new dialog will be displayed to enter the name for the new table. It is also required to select the type of table, to perform this action press the  button and the following dialog will be shown:

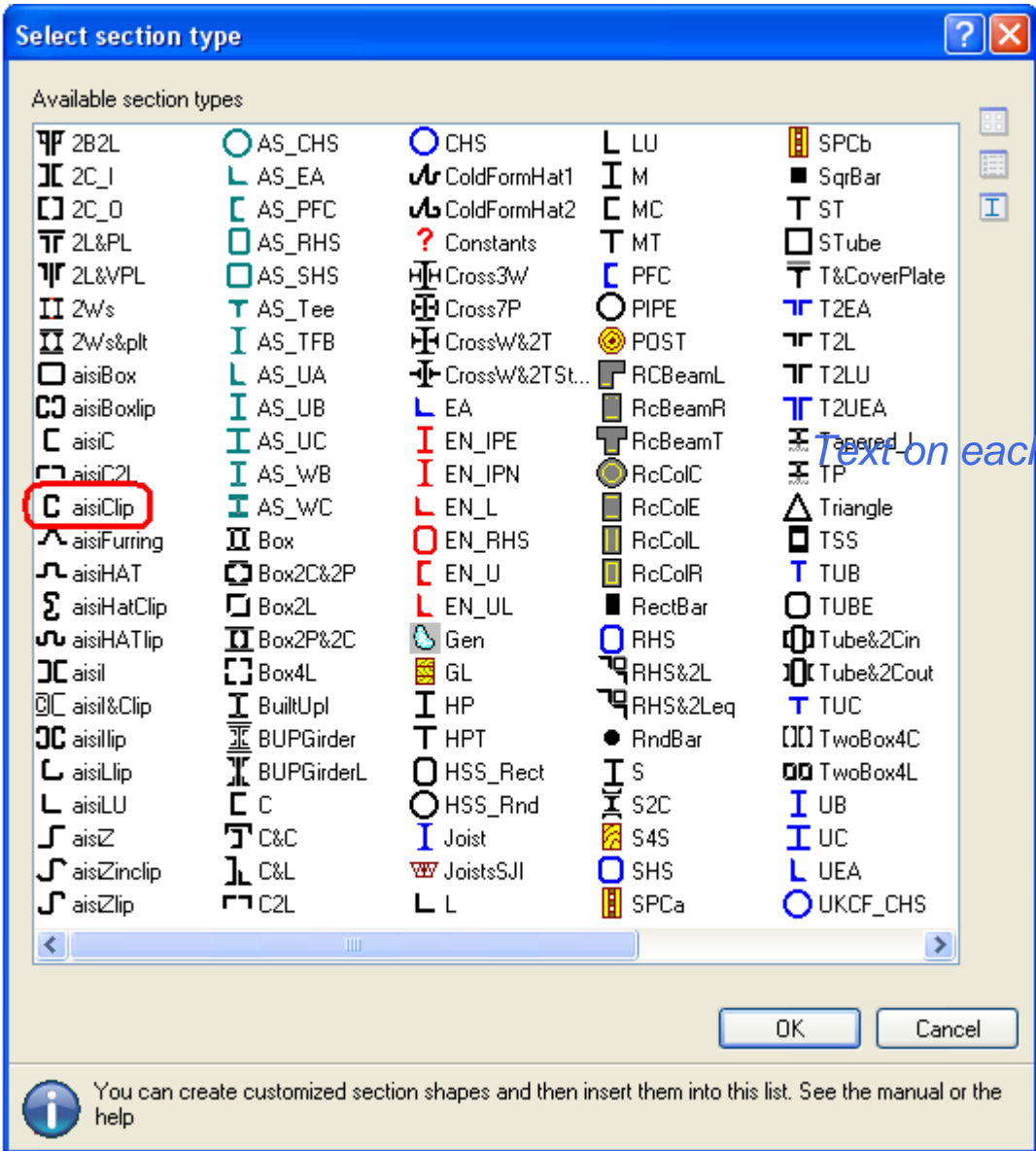

In the dialog window, select the desired type of profile and press OK. In this case, select the **aisiClip** profile.

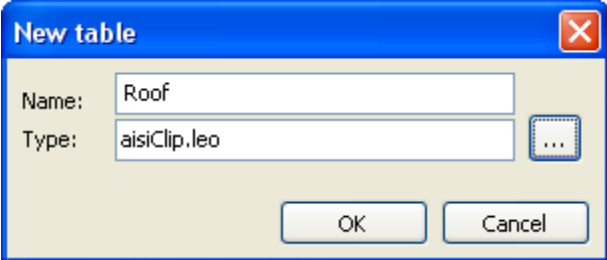

Once the type of table is selected, a LEO file for the definition of the type of sections is assigned to the table.

Press the  button to create a new item (section) for the current table.

Example 1: Steel

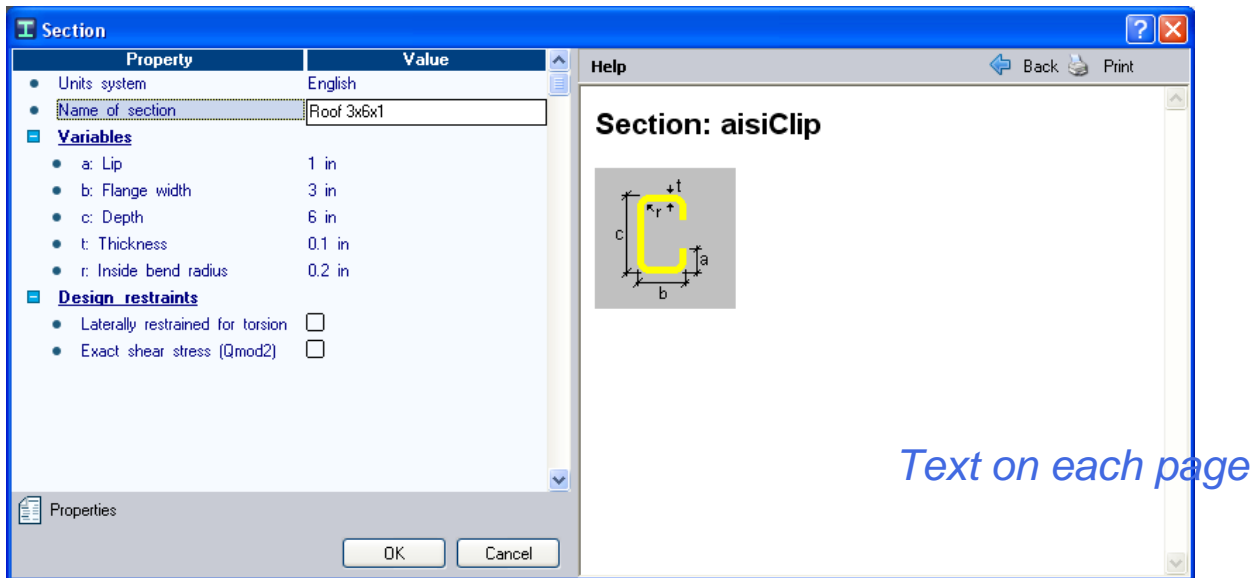

Select the units system (English) and enter the values of the profile. In this case, enter the values shown in the figure. Do not forget to enter the name.

Note. - The name of a section should have the following format:

Type<space>description

For example, W 10x45, where W is the type and 10x45 the description.

The space character should be placed after the type name. A description of the section should be entered. For example 10x25, 10x15x2 (the "/" character is not accepted. It should be replaced by "_" (underscore) character)

Note – A section “Type” is determined by the characters entered before the space, e.g. W, C etc

Tip. - The Description of the profile should be self-explanatory containing the dimensions of the profile or other pertinent data.

Example of valid names:

ROOF 10X15X25

W 10X25

2L 15x2 unequal

Example of non-valid names:

W10x25 (space between Type and Description is missing)

W15/22 ("/" character is not accepted. Replace it with "_" (underscore) character)

15x22 (Type is missing)

Press OK and notice that a new section "Roof 3x6x1" has been created and saved into the sections database. A new "ROOF" group, which will contain all profiles of type "ROOF", has been created.

Important. - The Type of a profile determines the group in which this profile will be saved. Thus a "W 10x22" profile will be saved in a "W" group or type. In the same way a "TUBE 15x22" profile will be saved in a "TUBE" group. If the group does not exist, RAM Elements automatically creates a new group.

Remark. Note that the program already has a section with the name “Roof 3x6x1”. The procedure described previously explains adequately the manner to perform this operation. It is recommendable that the user practices the creation of new sections for the structure in order to acquire proficiency in this task.

To assign the new section to the roof beams proceed as follows:

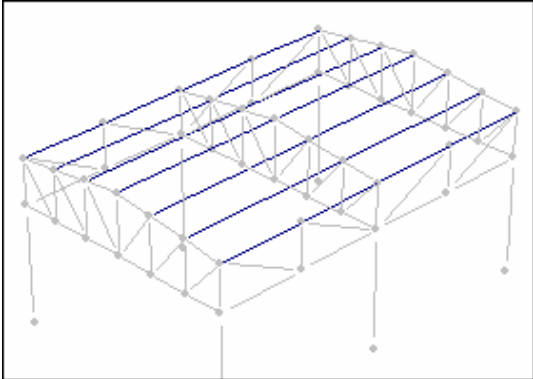

Text on each page

Select roof beams

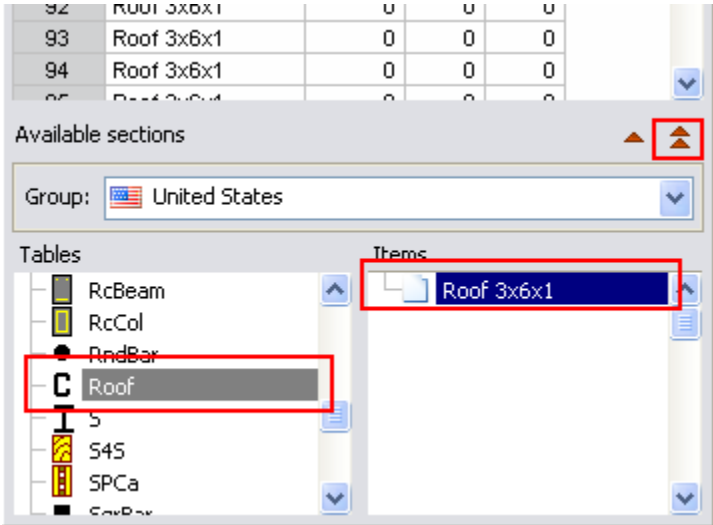

Assign the section by pressing .

15) Assigning materials

In this example, all material elements are of steel grade A36. To assign the material, proceed with these steps:

Select elements to which a material will be assigned. In this case, select all the elements of the

structure by pressing  All .

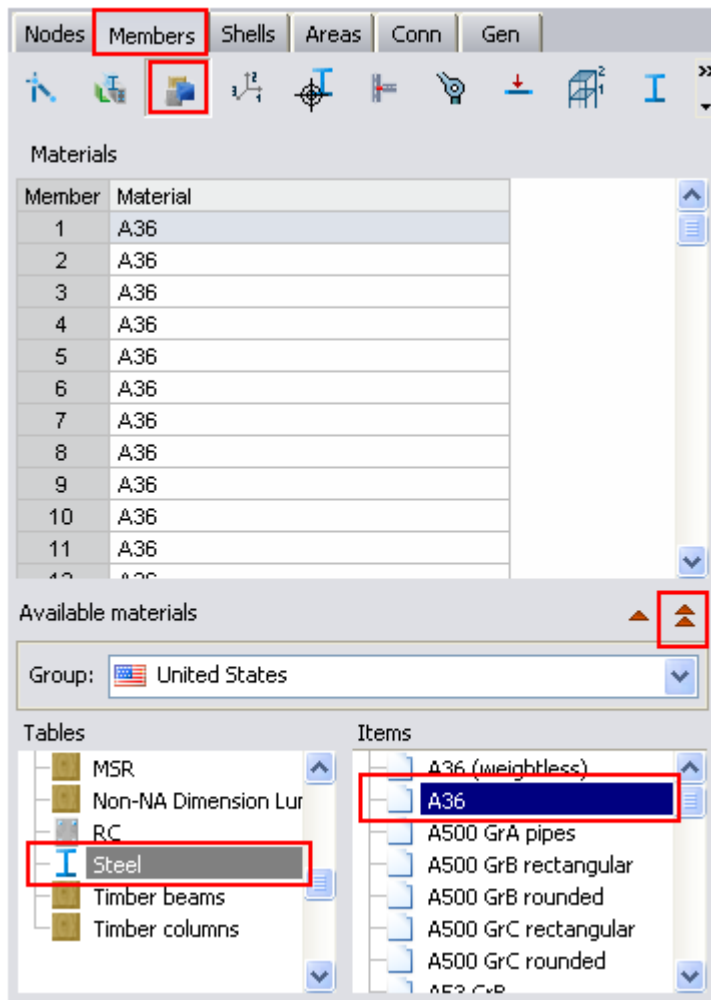

Example 1: Steel



Text on each page

Go to the Spreadsheet **Members/Materials**. Double click on the desired material, or select it and press 

Material “A36” from folder Steel has been assigned to all elements.

Note. - To show/hide the section and material names on the screen, press the  button and the  button from the *View tab, Model group*.

16) Articulated joints (pinned joints)

By default, all frame members are rigidly connected (fixed) to the nodes. This condition is appropriate to model a fully welded joint.

For joints that cannot resist flexural moments it is necessary to release the respective moments so the model adequately represents the real structure. An element is pinned when both ends of the members are released to both bending moments. To pin a member proceed as follows:

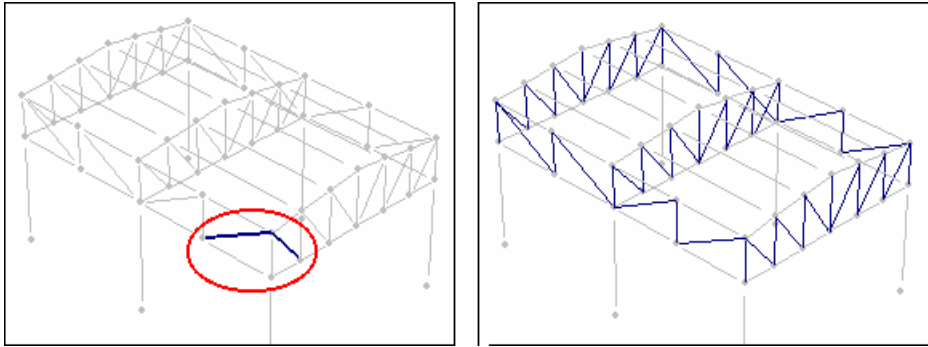

Select the members to be pinned. In this case, select DIAG1 and DIAG2 elements. To do this, select one DIAG1 element and one DIAG2 element. Then press .

Text on each page

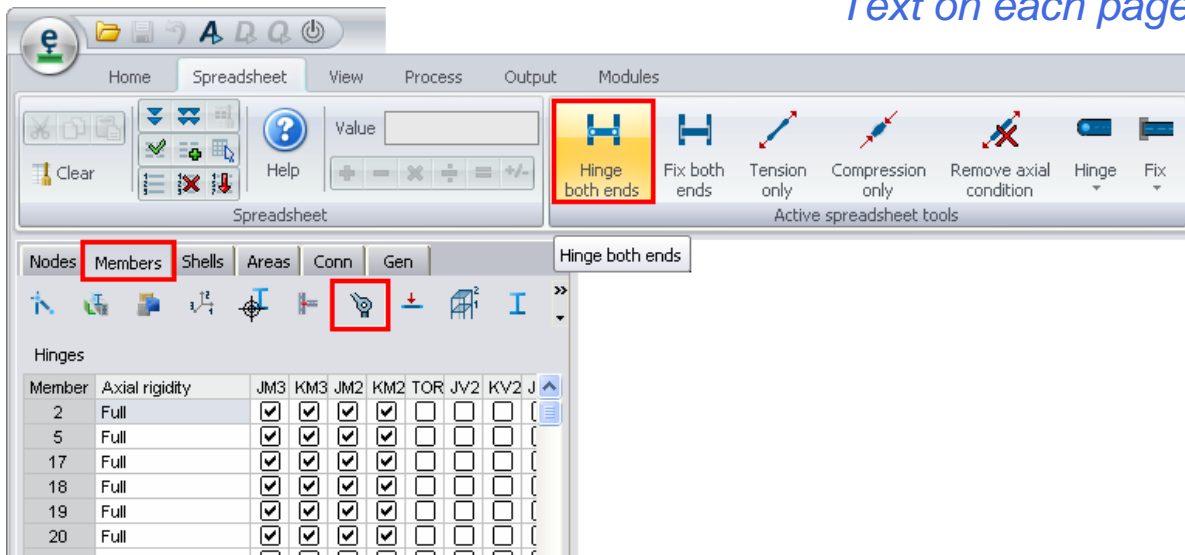

Go to the Spreadsheet **Members/Hinges** (Releases) and press button .



Note. - To rigidly connect pinned elements, press .

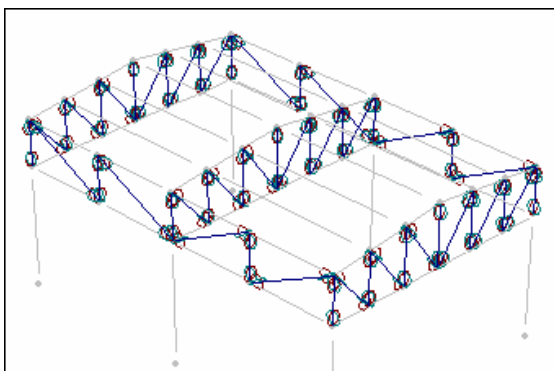

Elements have been pinned

17) Rotating columns



Pressing *Rendering* (in the *View tab, Model group*) the elements with three-dimensional sections are displayed. This allows the user to see whether the elements are orientated correctly in space or need to be rotated. If necessary, sections can be rotated as required. Tool buttons are available to rotate a member 90 and 180 degrees, or as required. In this case, the middle columns will be rotated by 90 degrees.

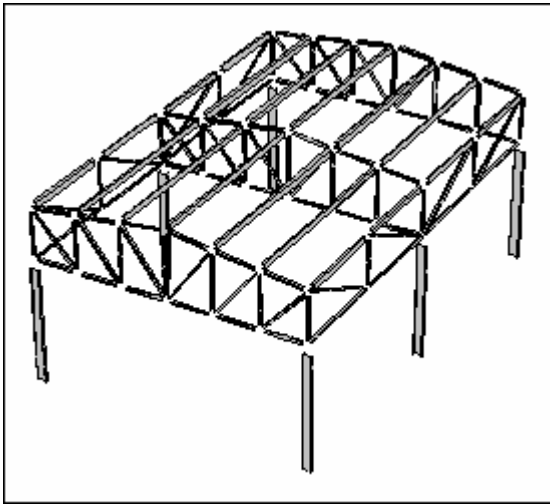

Text on each page



Press button *Rendering* to see the element profiles in 3D.

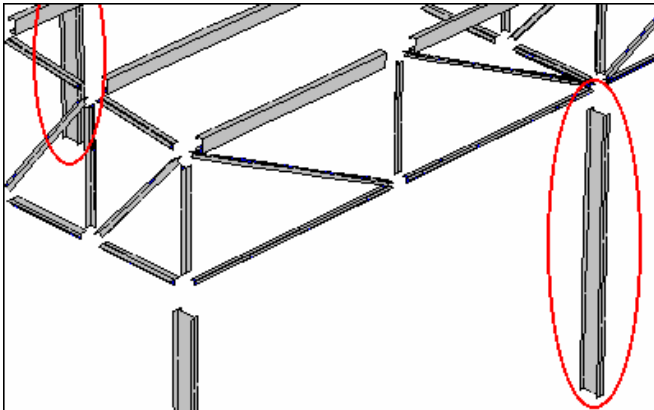

Columns in the middle will be rotated 90 degrees.

To rotate 90 degrees, proceed as follows:

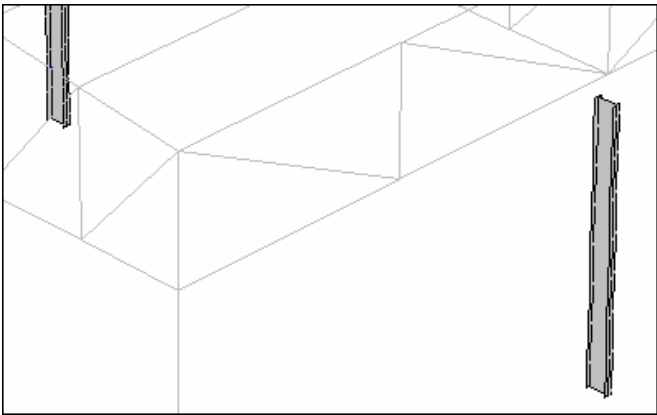

Select columns to be rotated

Text on each page

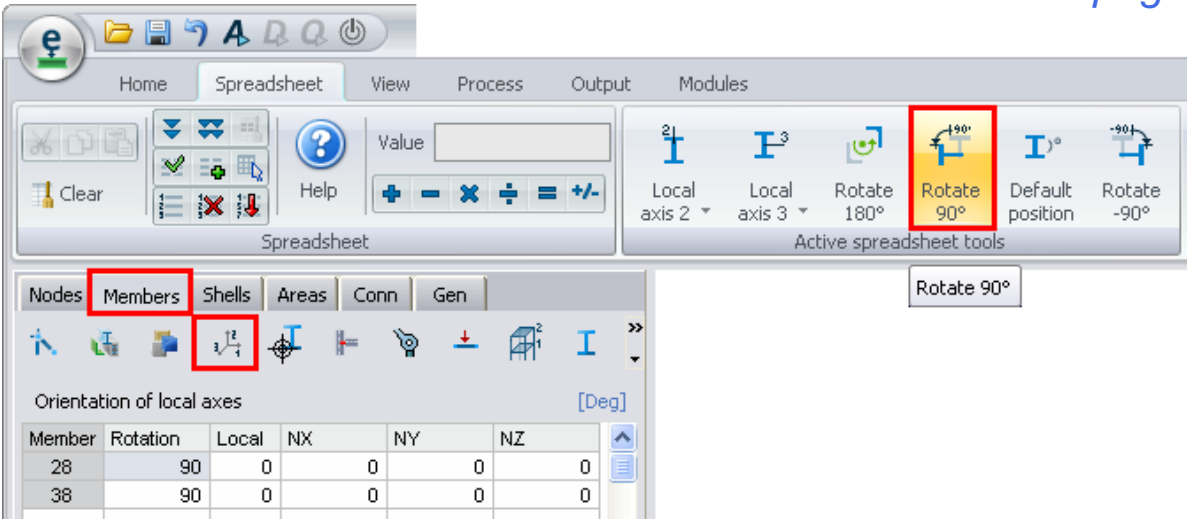

Go to the Spreadsheet **Members/Local axes** and press button

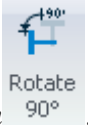

18) Rotating beams 180 degrees

In this example, the elements shown below need to be rotated 180 degrees.

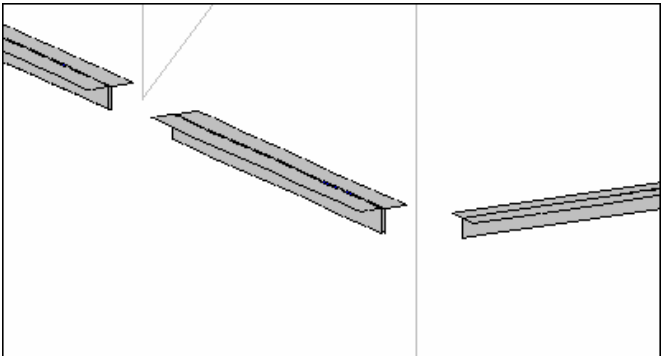

BEAM2, BEAM3 elements need to be rotated 180 degrees

To do this, follow the next steps:

Example 1: Steel

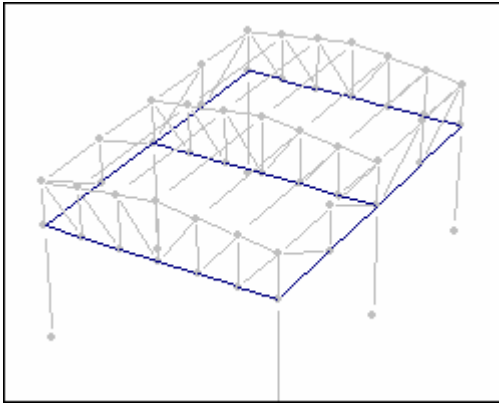

Select BEAM2 and BEAM3 elements (select one BEAM2 and BEAM3 elements and press button ).

Text on each page

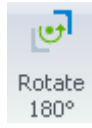
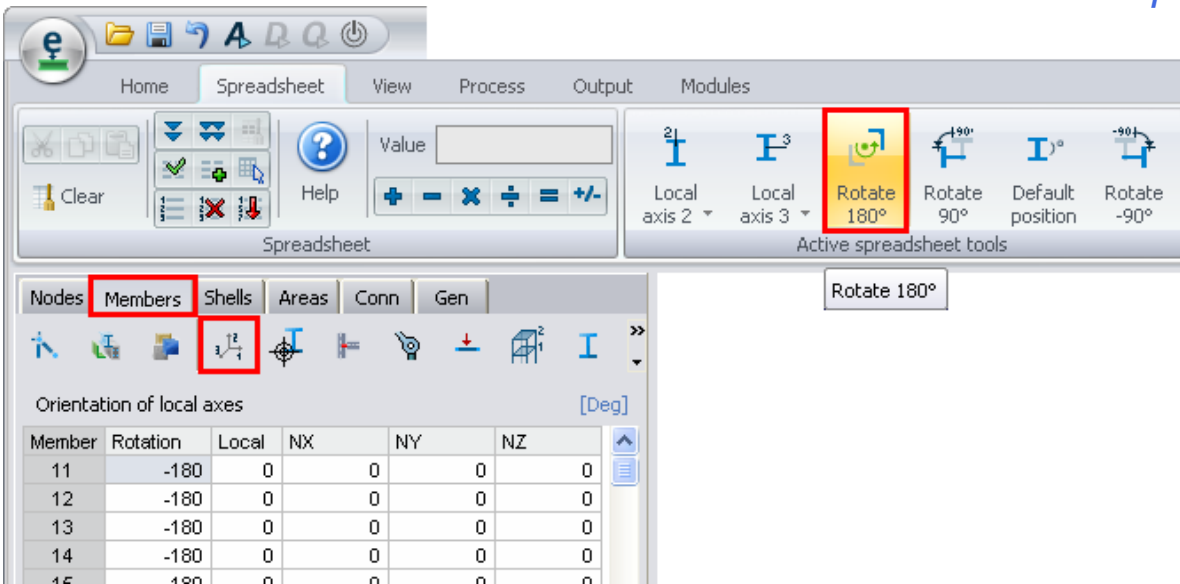

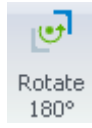
Go to the Spreadsheet **Members/Local axes**, and press button  to rotate 180 degrees.

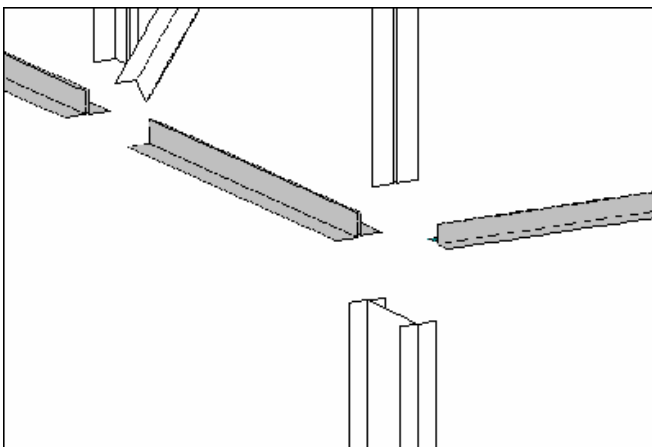

Elements have been rotated 180 degrees.

Note. - Notice that it is possible to rotate the members by entering the required angle in the spreadsheet and pressing  to fill the column with the entered value.

19) Entering loads

In this example, a 300 Lb/ft distributed force acting downward in the "Dead Load" case will be introduced. Concentrated forces of 1200 Lb, which are acting downward on the nodes, will be added as well.

Notice that RAM Elements automatically creates a load case named "Dead Load". Therefore, it isn't necessary to create it. Later the user will see how to create a new load case and a load combination.

Before entering a load, determine if it is a:

- 1) Load on node
- 2) Load on frame members, or
- 3) Load on shell elements.

Text on each page

Load on frame members

To enter loads on frame members, proceed as follows:

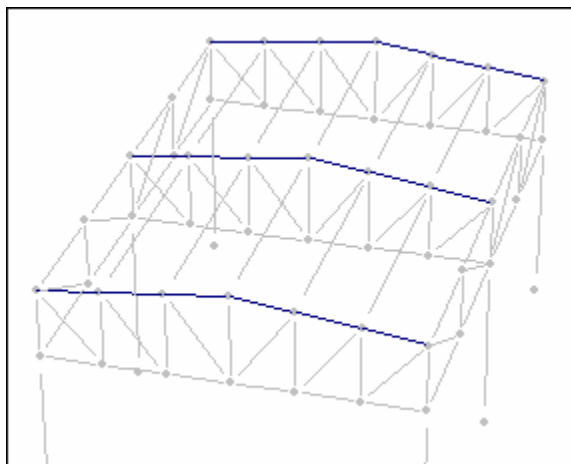

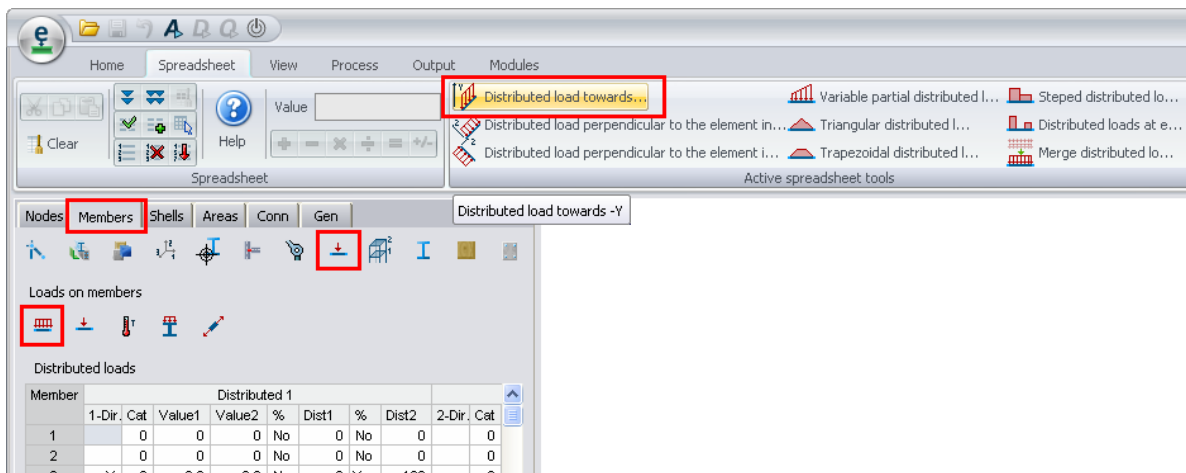

Select frame members where the load is acting. In this case, select beams on top of the truss.



Example 1: Steel

Go to the Spreadsheet **Members/Loads on members**, select the adequate command tools by pressing

the  button and then press the  button.

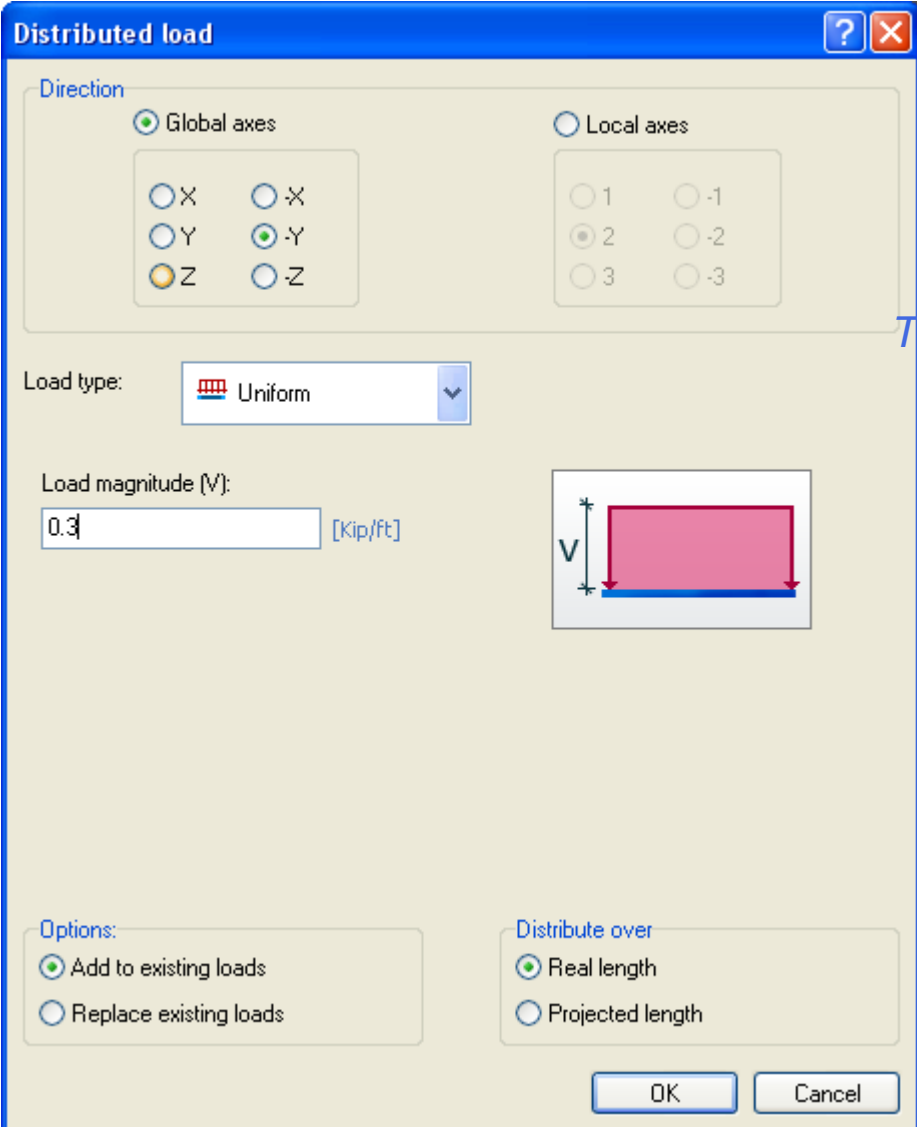

Distributed load

Direction

Global axes

Local axes

X -X

Y -Y

Z -Z

1 -1

2 -2

3 -3

Load type:  Uniform

Load magnitude (V):

0.3 [Kip/ft]



Options:

Add to existing loads

Replace existing loads

Distribute over

Real length

Projected length

OK Cancel

Text on each page

Enter the value of the distributed load (do not enter the minus sign). Then press OK.

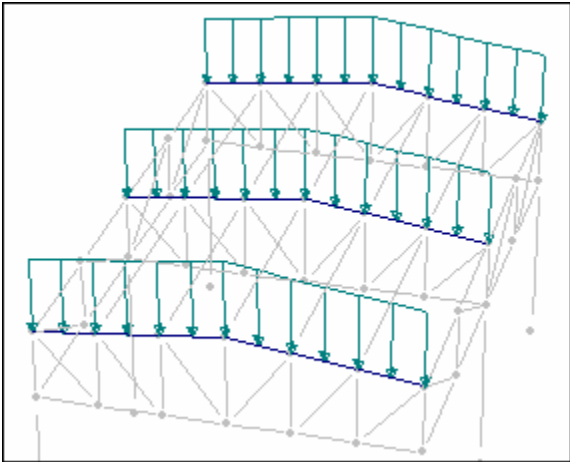

The load has been entered.

Text on each page

Load on nodes

To enter load forces on nodes, follow the next steps:

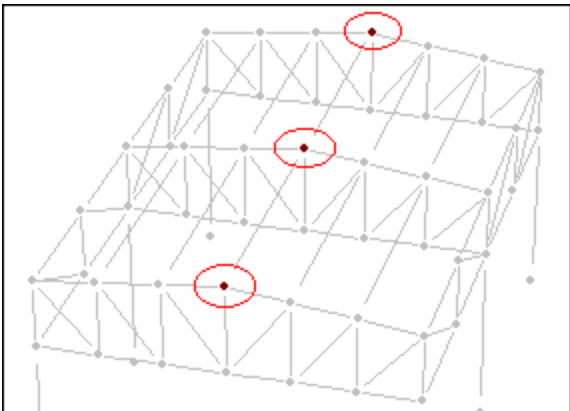

Select the nodes on which the force is acting.

Nodes Members Shells Areas Conn Gen

(x,y) [Icons]

Forces and moments [Kip]

Node	FX	FY	FZ	MX	MY
7	0	-1.2	0	0	0
25	0	-1.2	0	0	0
27	0	-1.2	0	0	0

Go to the Spreadsheet **Nodes/Forces and moments**, enter a force value (enter the -1.2 value) and press to fill-in the column.

Example 1: Steel

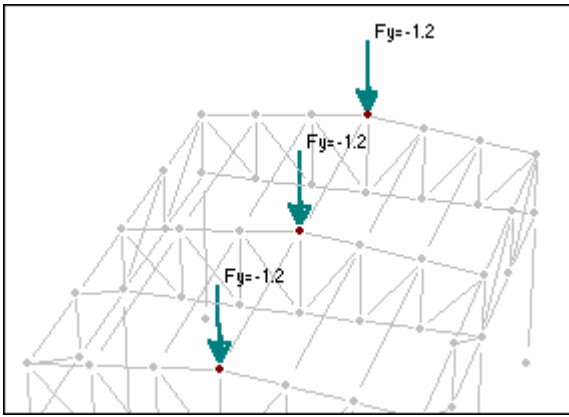

Notice that the force should include its sign. Forces on nodes have been entered *Text on each page*

20) Creating Wind in X load case

The Second load case acting on the structure is due to the wind force in the X direction. These steps show how to create a new load case:



Execute the shown button located in the Home tab, Load conditions group to enter a new load case.

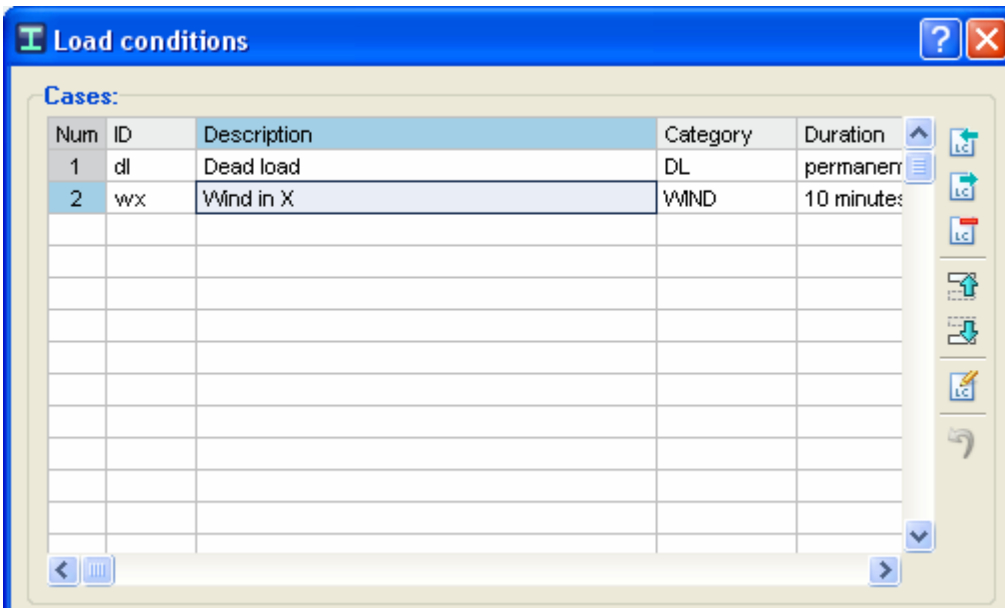

Then enter a load condition identifier consisting of 2-4 characters (first character should not be a number), then enter a load description and the category. In this case, enter what is shown in the figure. Press OK and the new load case in the drop-down list will be shown.

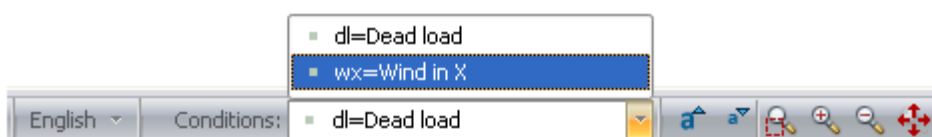



Drop-down list for load cases at the status bar.

Note that it is necessary to select a category. This feature is very useful to generate load combinations based on their categories. The user can create a template file for the local building code from which load combinations can be generated (based on the load case category, DL for dead loads, LL for live loads, etc.). The program is capable to generate load combinations according to the design standards it handles and it has example files (located at main RAM Elements directory/*combos*) which have the basic load combinations to consider for the different codes. For more details see the chapter of Other Advanced Subjects in the program manual.

21) Entering wind loads

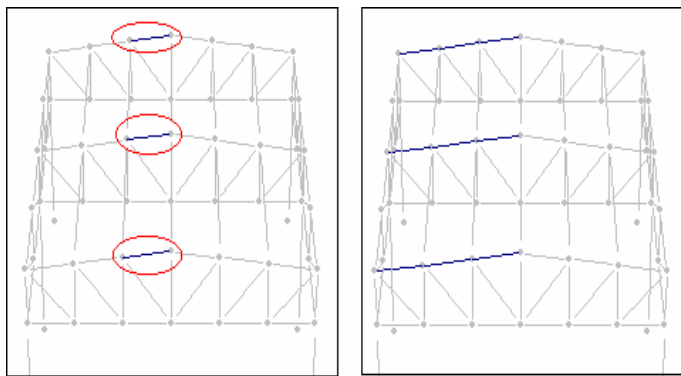
In this case, wind loads are applied perpendicular to the roof. There is a pressure of 150 Lb/ft on the left side of the roof, and a suction of 200 Lb/ft on the right side of the roof. Wind load entry is similar to the entry made before for the dead load condition. Notice that the distributed forces act perpendicular to the elements, not parallel to Y-axis. To enter these loads, proceed as follows:



Select the elements on which the load acts. In this case, select one member of each portal and press  to select the aligned elements.

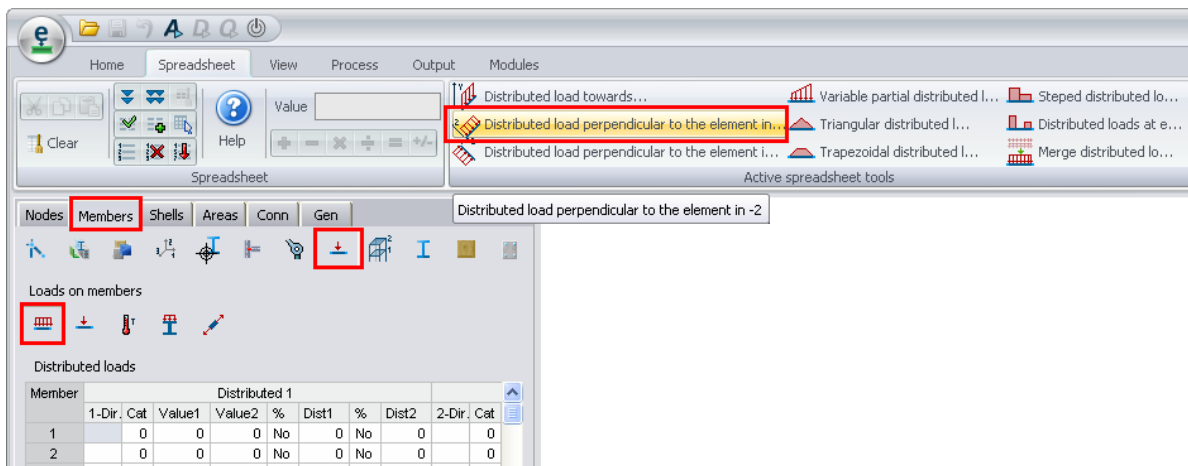

*Go to the Spreadsheet **Members/Loads on members** and press the  button.*

Example 1: Steel

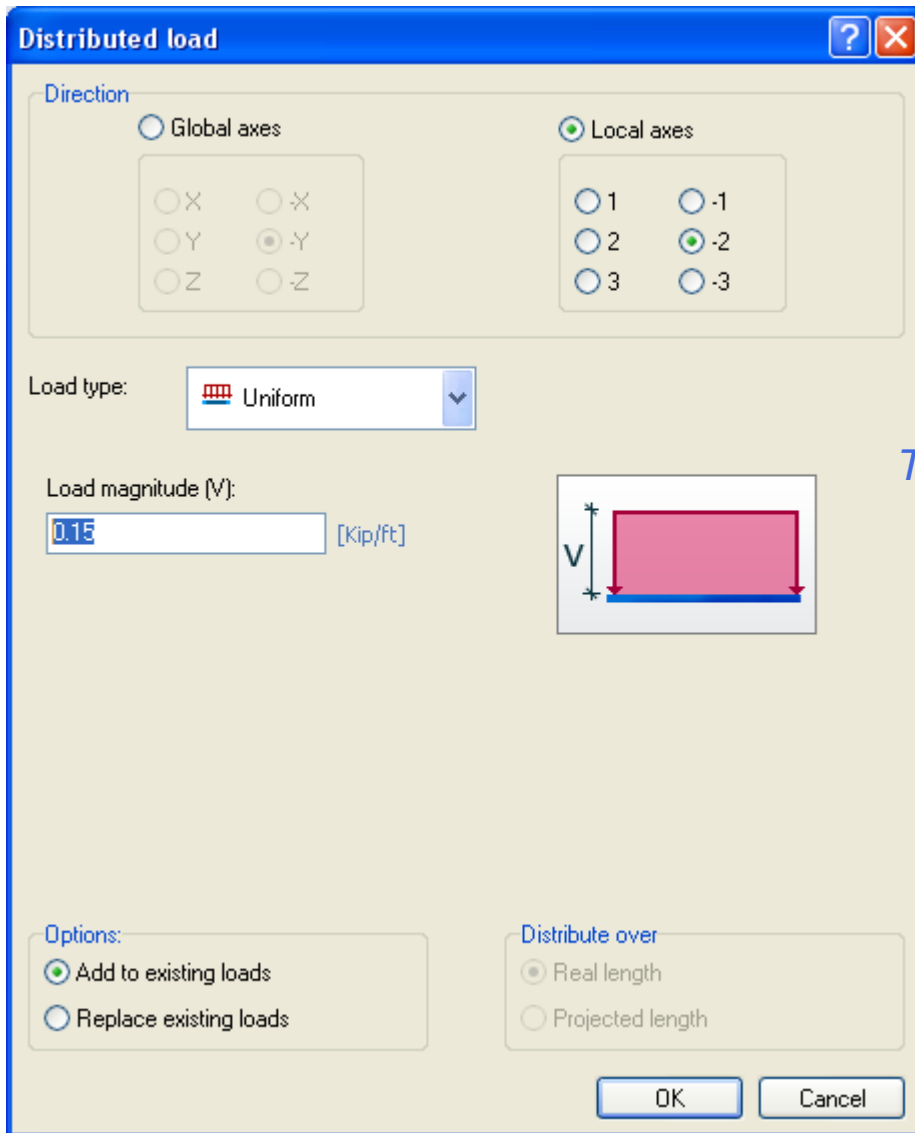

Text on each page

Enter the value of the distributed force (do not enter the minus sign), and press OK.

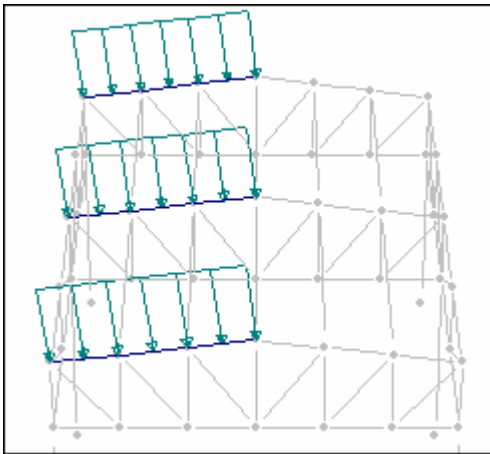

The distributed forces of the left side of the structure have been entered.

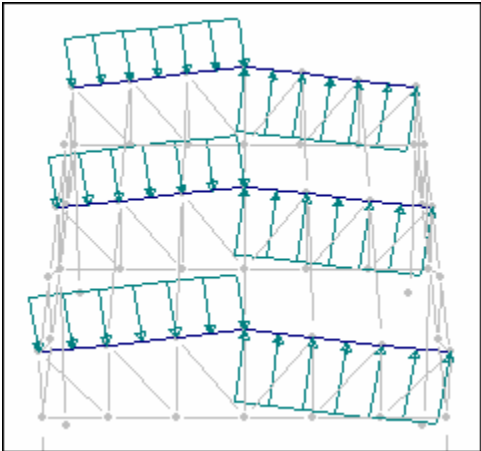

Text on each page

To enter the forces on the right side of the structure proceed as before. The load should be seen as illustrated in the figure.

Notice that it is necessary to press button  instead of button  to enter suction.

22) Creating load combinations

In this example, the following load combination will be created:

$1.1dl + 1.2wx$ (1.1 times dead load plus 1.2 times wind in X)

To create it proceed as follows:



Execute the shown button located in the Home tab, Load conditions group to enter a new load case. Fill the combination equation factors in the second spreadsheets in the dialog window that appears.

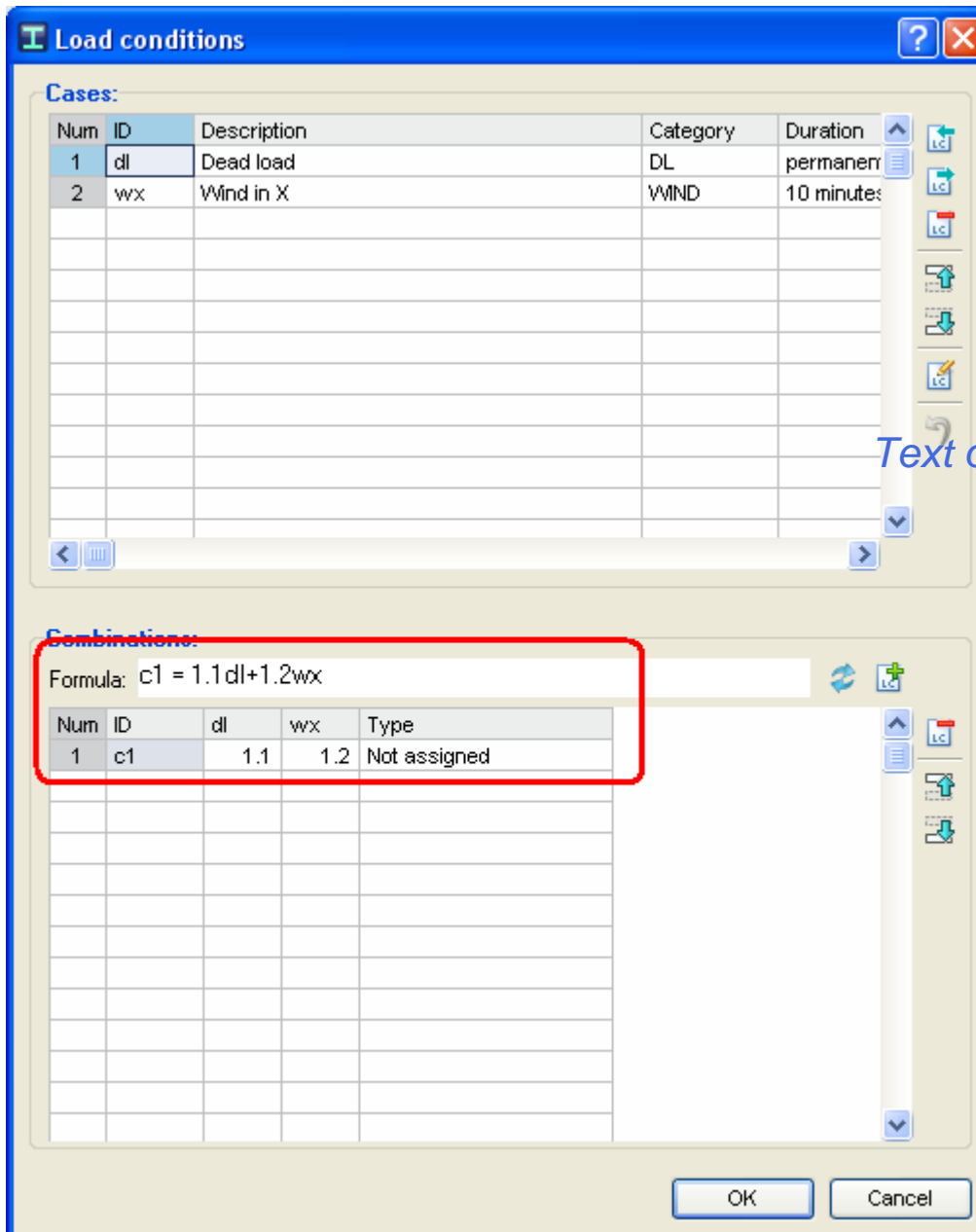

Text on each page

In the dialog window, enter the information shown in the figure.

- Enter a load condition identifier of two to four characters (the first character should not be a number).
- Enter the formula factors for the load combination (1.1 for dl and 1.2 for wx).

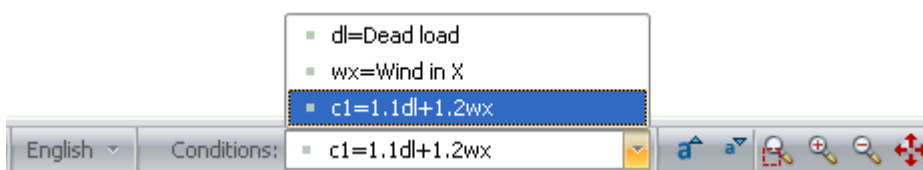

Then press **OK** and the new load combination in the drop-down list for load cases at the status bar will be shown.

Notice that the formula factors can contain the minus sign. For example, a -1.2 factor for wx load case would define "1.1dl -1.2wx"

Note. - It is not possible to enter or edit loads data while a load combination is selected as the current load condition. Notice that the spreadsheets are locked for edition to enter loads.

23) Analyzing the structure

After the structure has been defined, the model is ready to be analyzed, designed, optimized and the results can be viewed.

To analyze the structure proceed as follows:



Text on each page

*Execute **Analyze model** by pressing the shown button in the *Process tab, Process group*.*

For this example a Second Order Analysis (P-Delta) will be performed. This analysis takes longer to analyze a structure as it involves iteration, but it is more accurate. In addition, buckling instability is detected in certain cases when P-Delta analysis is performed. For more about P-Delta analysis, see the Chapter of Analysis in the Manual.

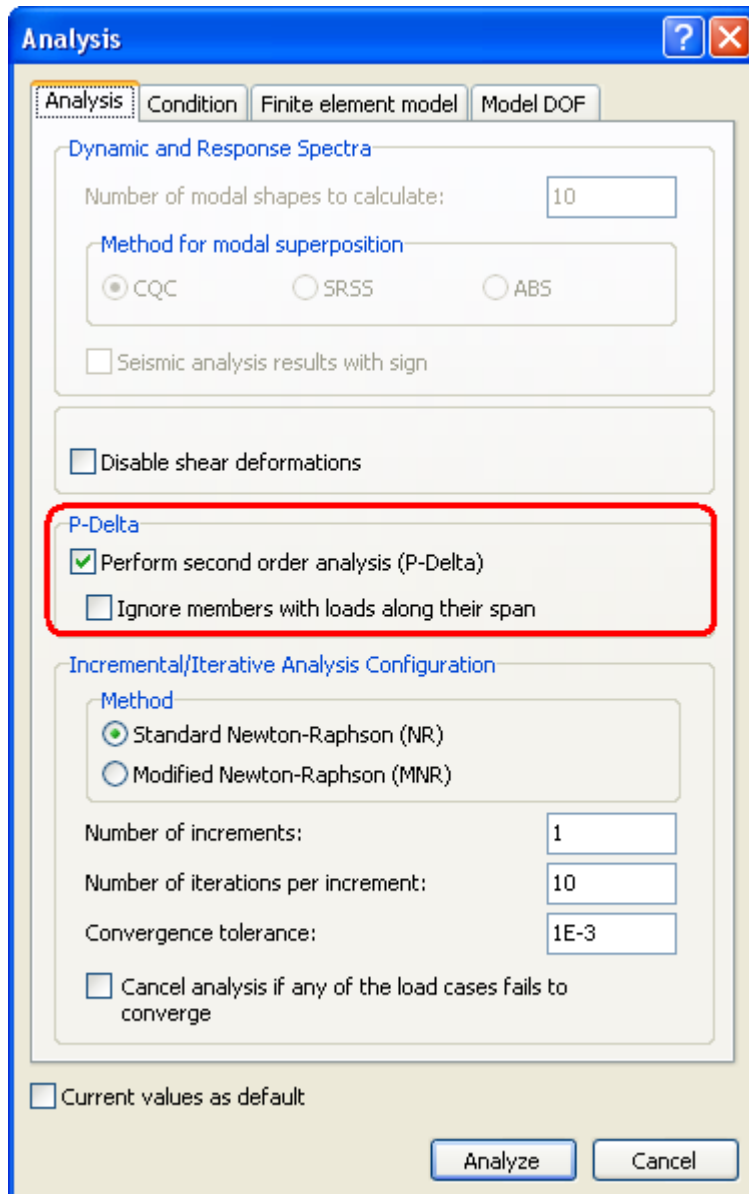

Text on each page

Select the same options as shown in the figure above. Then press the Analyze button.

24) Designing the structure



Select the command Design all in the Process tab, Process group.

After that, a dialog window will be shown to specify the design standard to be used in the design of members. For this example select AISC 360-05, AISI-01 (ASD) for steel members. The other material options may use the code defined by default.

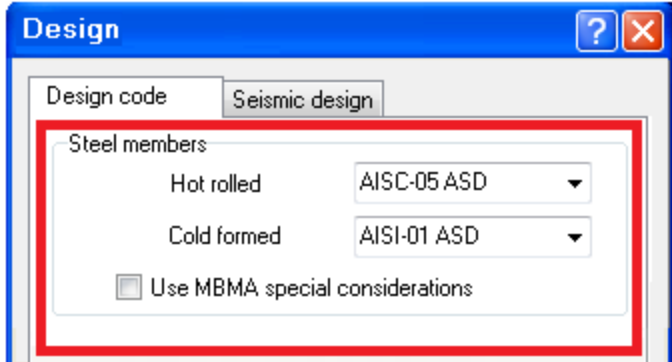

Text on each page

Select the design code shown above and press the Design button.

Once the elements are designed, the user has the option to optimize the sections with the following command.



Select the command Optimize model in the Process tab, Process group.

For this example the optimization is not performed.

25) View results graphically

As can be seen, several buttons (in the Analysis and Design groups of the View tab) are enabled once the structure has been analyzed and designed. These newly enabled buttons allows the user to select what results to display.

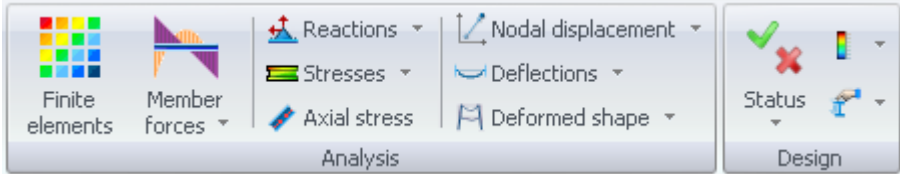

Result buttons from the Analysis and Design groups are enabled when the structure has been analyzed/designed.

In order to see results graphically, press the button corresponding to those desired items, and then select the elements to see the results.

Notice that the selected display options will only be seen on the selected elements.

Example 1: Steel

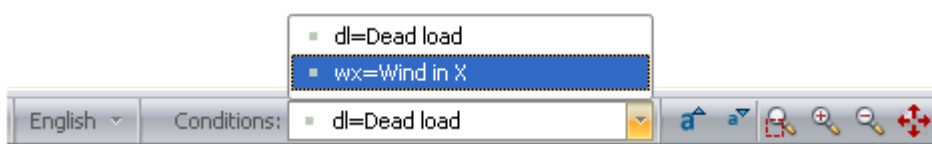



Select the load condition.

26) Deformed shape

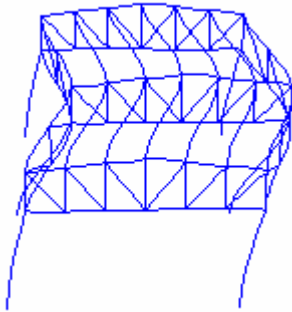
One of the first display options that should be viewed is the deformed shape of the structure.



Text on each page

To see the deformed shape, press  Deformed shape . The graphic shown corresponds to the Wind in X load case.

In this view the elements are drawn as lines. To see the deformed shape with the original shape select the option .

27) 3D Sections Deformed shape

It is possible to see the deformed shape with the extruded sections.

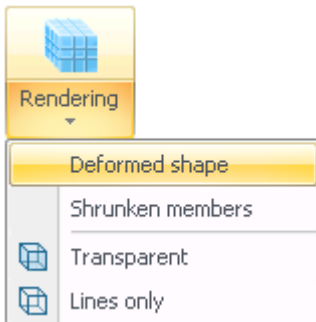

Activate the deformed shape accessing the option from the Rendering button menu (*View tab, Model group*). Notice that this view may take a longer time to draw.

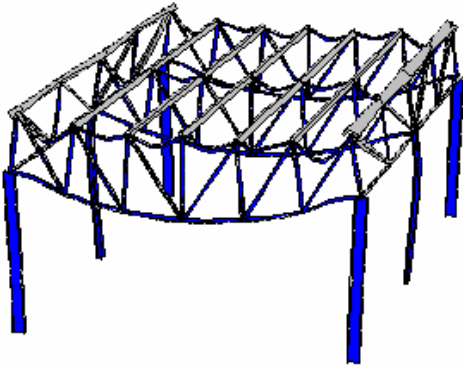



The graphic shown corresponds to the Dead load case.

Text on each page

28) Stress

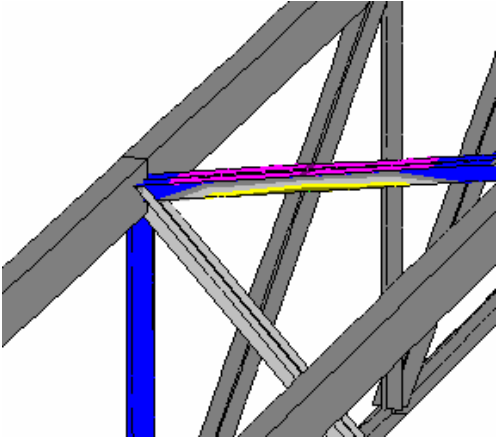
Another important view option is the information related to the element stress contour. This is of particular importance in light gage structures where stress concentrations are significant to the design.



Press the  button to see frame member stresses. Note that the button has a menu where there are some options to see the stresses in the deformed shape or in shrunken members.

To select only those elements that are stressed within a certain range, mark a block of stresses with the mouse and press .

Example 1: Steel

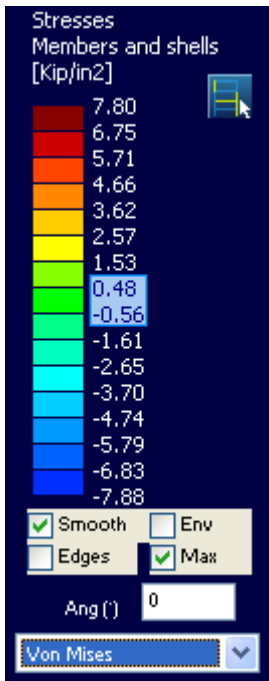

Text on each page

To see element stresses within a certain range, mark the range and press .

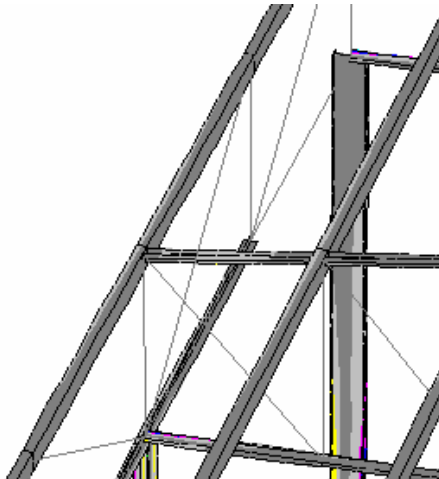

RAM Elements selects those elements whose maximum stress is within the marked range of stresses. Note that the remaining members are recalibrated (color changes).

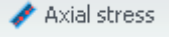
Note. – To see only the axial stress (without bending moments, press ).

29) Stress and deformation

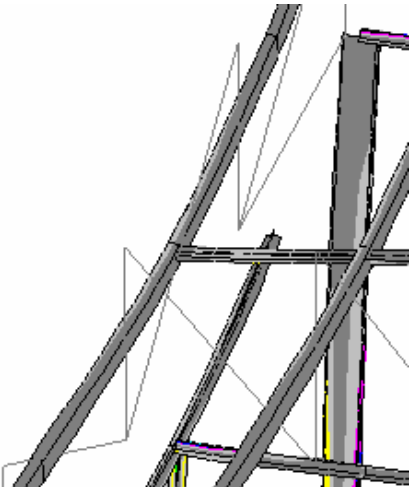

Text on each page

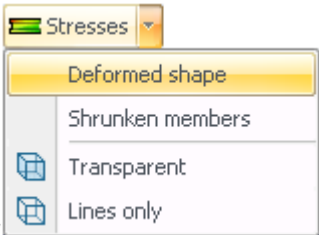

To view stress and deformation of the elements, activate these buttons

30) Forces diagrams

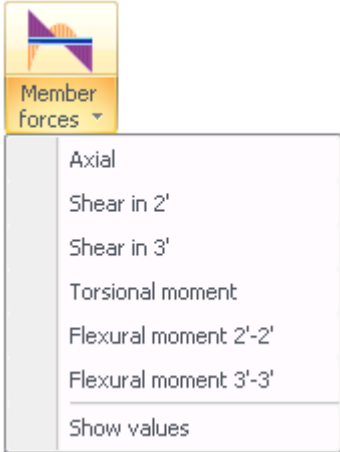

The buttons shown above (View tab, Analysis group, Member forces displayed menu) allow the user to see the forces diagrams of the frame members:

Bending moment around element axis 3 (Typically strong axis bending)

Example 1: Steel

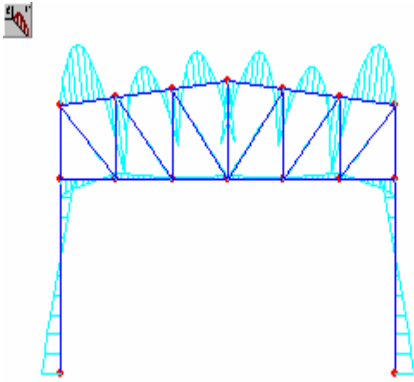

Bending moment around element axis 2 (Typically weak axis bending) *Text on each page*

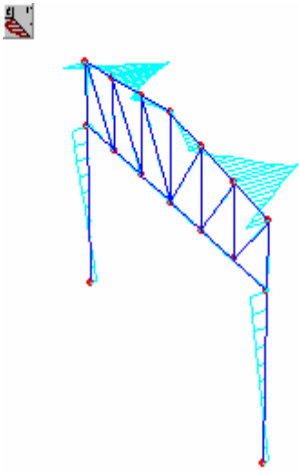

Shear forces in element axis 2 (typically weak axis) (Dead load case)

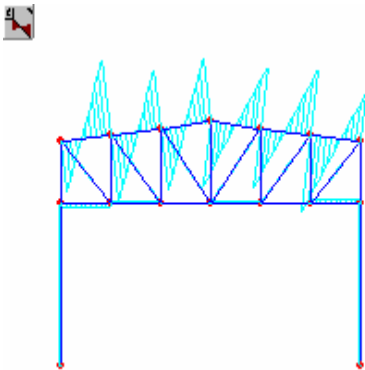

Shear forces in element axis 3 (typically strong axis) (Dead load case)

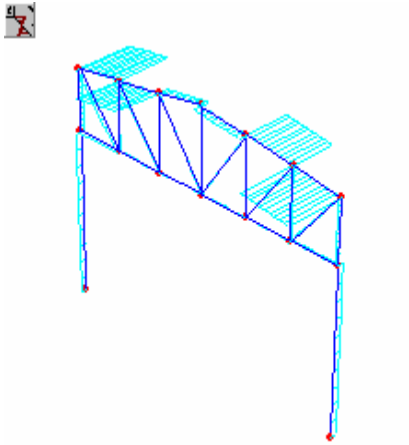

Torsion (Wind in X load case)

Text on each page

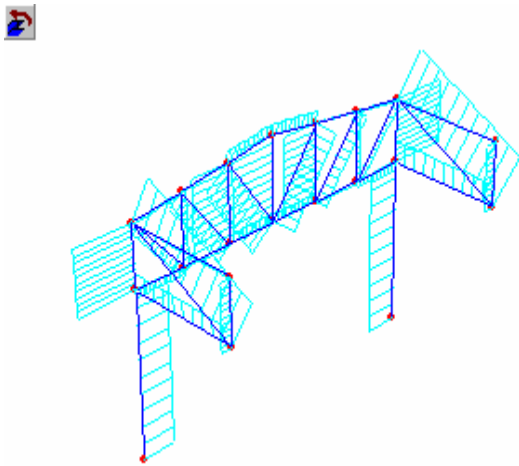

Axial forces (Dead load case)

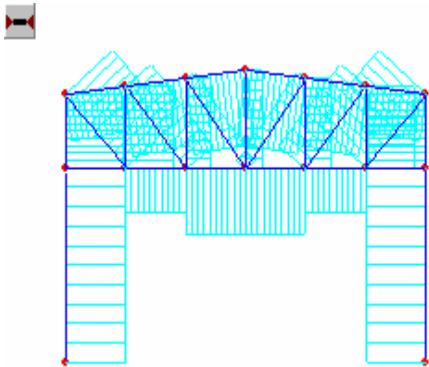

Select the Show values option (Member forces menu) to simultaneously display the magnitude of the forces.

Example 1: Steel

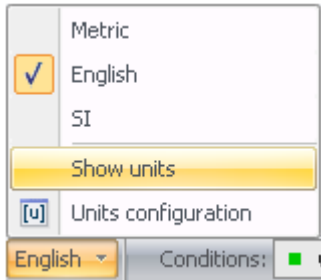

Select *Show units* option (menu displayed for units at the status bar) to display the units.

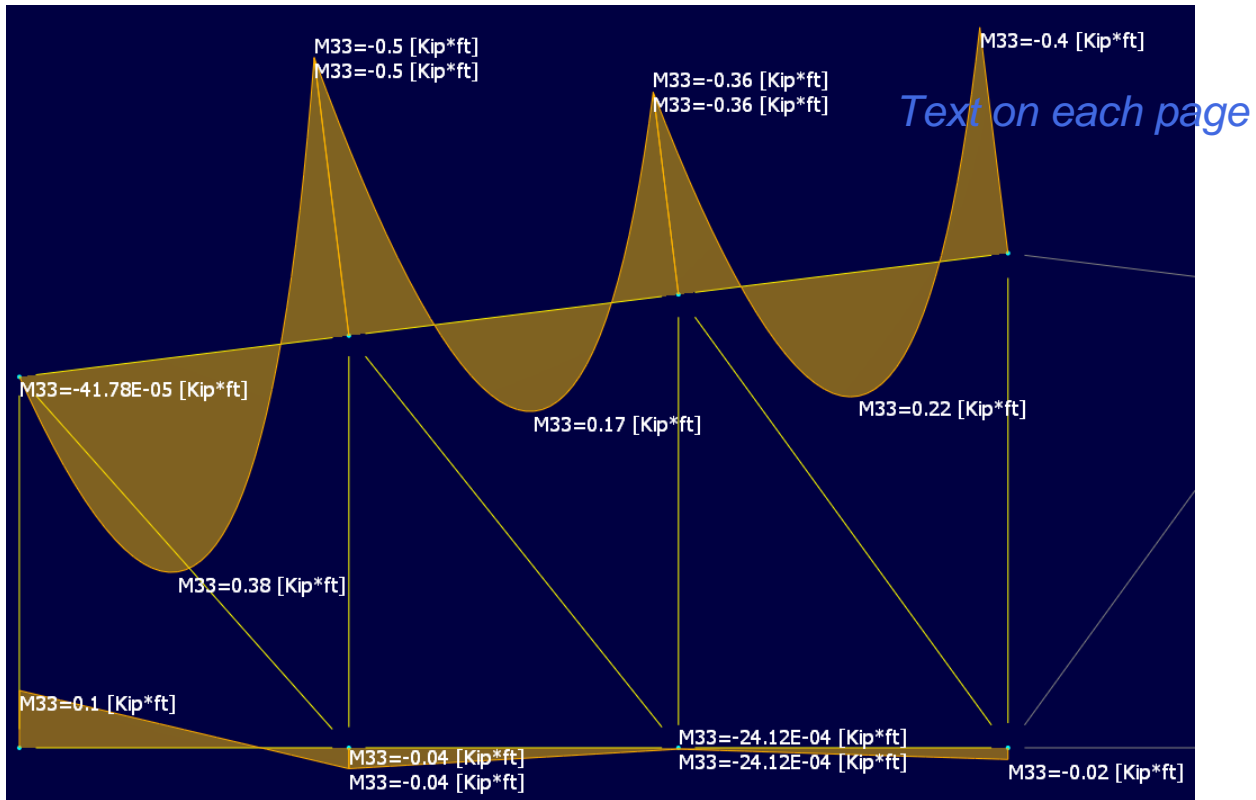

31) Displacements of nodes

To see the nodal displacement values, press  Nodal displacement (View tab, Analysis group) and choose the degree of freedom to be viewed:

Tx
Ty
Tz
Rx
Ry
Rz

The relation between a degree of freedom and its respective displacement in the global coordinate system is as follows:

1: Tx: X translation

- 2: Ty: Y translation
- 3: Tz: Z translation
- 4: Rx: Rotation about X
- 5: Ry: Rotation about Y
- 6: Rz: Rotation about Z

Note. – Notice that X, Y, and Z represents the global coordinate system.

Each element has its own system of coordinates, named local axes. These axes are designated with the numbers 1, 2 and 3, which are equivalent to X, Y, and Z-axis. Local axes are Cartesian and follow the right hand rule. To see the local axes, press  Local axes (View tab, Model group).

Text on each page

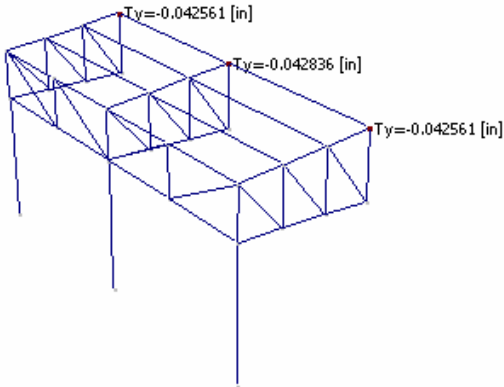

Press  Nodal displacement and the degree of freedom corresponding to the displacement.

To see the displacement units press the *Show units* option in the Units menu at the status bar.

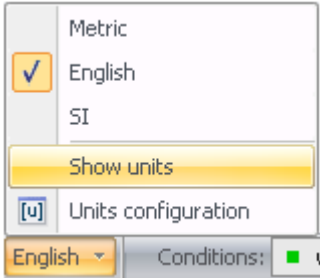

32) Reactions

To see reactions, press  Reactions (View tab, Analysis group) and the degree of freedom corresponding to the desired action.

Tx
Ty
Tz
Rx
Ry
Rz

Example 1: Steel

This is the relation between degree of freedom and force:

- 1: Tx: X force
- 2: Ty: Y force
- 3: Tz: Z force
- 4: Rx: Moment about X
- 5: Ry: Moment about Y
- 6: Rz: Moment about Z

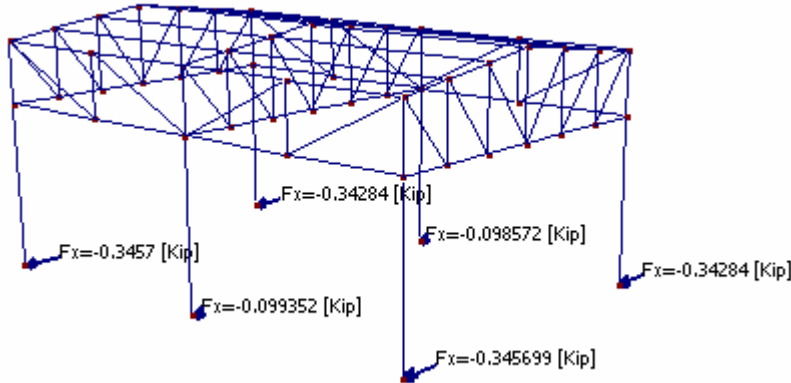

Text on each page

Press  and the degree of freedom that corresponds to the desired reaction. (Case: Wind in X)

33) Deflections

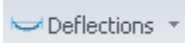
One of the most important results of an analysis is the ratio between deflection and length of the element. To view this ratio press  (View tab, Analysis group).

Defl/L
Defl. in axis 2
Defl. in axis 3
Defl=f(L) in axis 3
Defl=f(L) in axis 2

Options displayed in the Deflections button menu.

This ratio may vary across an element. RAM Elements displays the maximum ratio found within an element.

Note. – The Defl/L ratio should never exceed a value suggested by the design code and judgement.

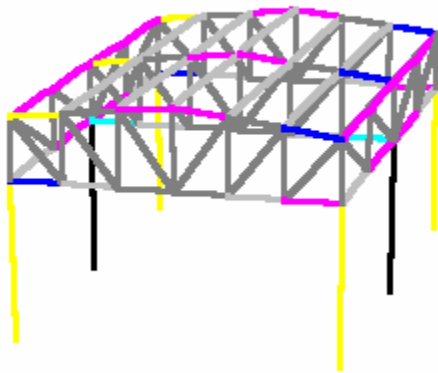

Text on each page

Press  to see the element colored Defl/L ratios.

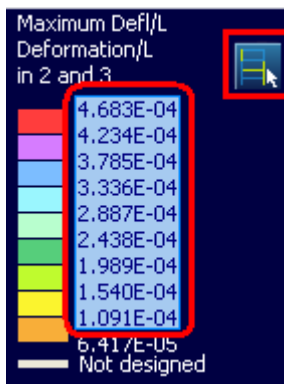

In this panel mark a range of Defl/L ratios and press  to select the elements that have slopes within the marked range.

34) Deflection values

To see the Deflection values (in function of L) in local axis 2 direction, selection option  .

To see the Deflection values (in function of L) in local axis 3 direction, press button  .

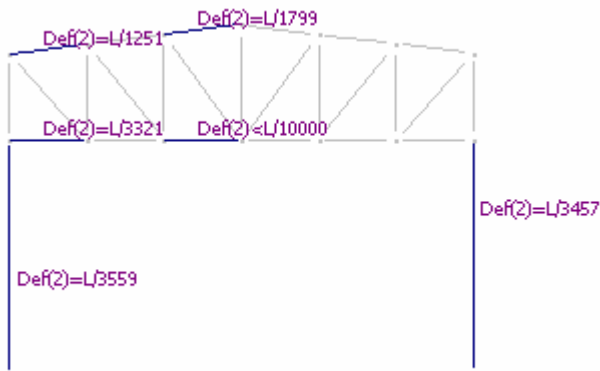

Example 1: Steel

Deflection in function of L for the Load combination C1.

35) Design: Colored Interaction Values

To view interaction values graphically, by color, press  (View tab, Design group).

Important!

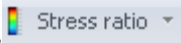
To view the interaction colors scaled from 0 to 1.0, press . To view the controlling interaction value for all Load Combinations (not load cases) press

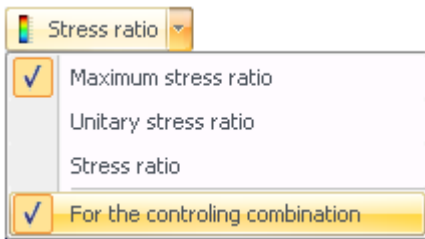

Text on each page

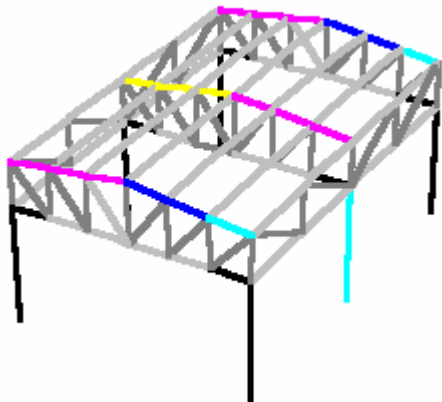

Press  to see interaction values.

To select the elements with stress ratio within a certain range, mark a range of stress ratios and press .

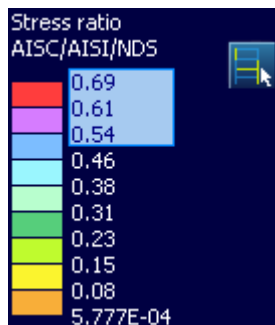

Mark a block with the mouse and press button  to select elements with stress ratio within the range.

Note that most of the results displayed to this point are for the selected load condition.

36) Design: Interaction Values

To see interaction values for the currently selected load condition, press

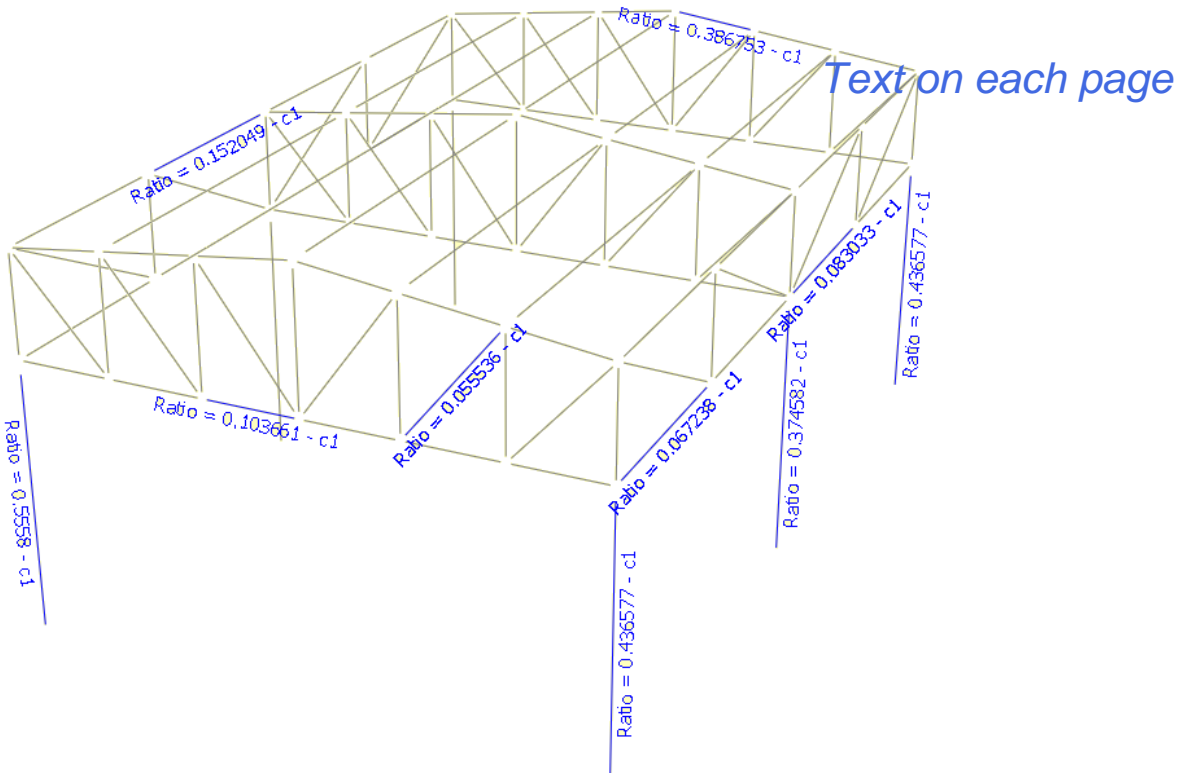
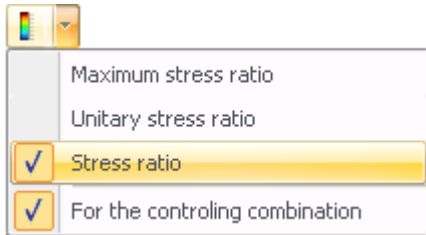

Choose the Stress ratio option to view interaction values for the current load condition. The last option of the menu should be enabled to see the ratios for the governing load combination.

37) Design: OK and NG (No Good) elements

To view the elements that failed code check (for the current load condition), press



(View tab, Design group):



Example 1: Steel



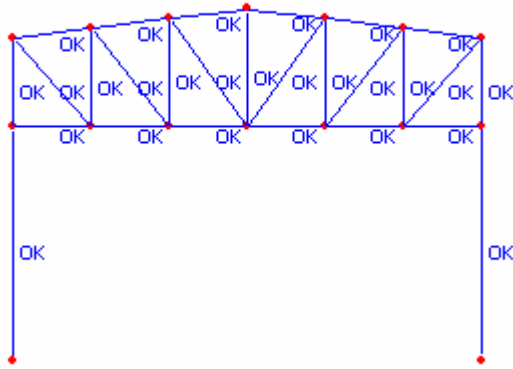

Press *Status* to view elements that failed code check.

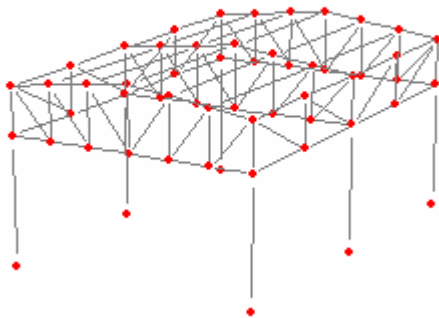

Text on each page

Press button  to see elements that pass code check.



Press button  to quickly select all elements that failed code check.

The user can print the results of the steel design in a report. To print them, go to the *Output tab, Reports group*. For more information about reports see the Printing Graphics and Reports Chapter in the manual.

The user can also use the optimization feature that is valid only for steel and wood members. This option allows the user to change the existing sections with sections that are recommended (based on explicit criteria) from a collection of sections. In other words, the original section can be replaced with another that resists the imposed loads with an allowable deflection and that is located above the original section in the list of sections specified for the optimization. To use the optimization feature go to the *Process tab, Process group, Optimize model command*. For more details see *Chapter 11: Steel and Wood Structure Optimization and Code Check* of the Manual.